

DOUILLE 1/4"

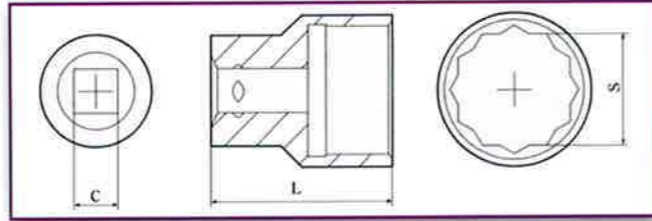

Sockets
Steckschlüsseinsätze
Cubos



S inch	L mm	C inch	Qualité	Réf	S inch	L mm	C inch	Qualité	Réf
4	25	1/4	Be-Cu Al-Br	013904 026704	5/32	25	1/4	Be-Cu Al-Br	032502 036302
5	25	1/4	Be-Cu Al-Br	013905 026705	3/16	25	1/4	Be-Cu Al-Br	032505 036305
6	25	1/4	Be-Cu Al-Br	013906 026706	7/32	25	1/4	Be-Cu Al-Br	032508 036308
7	25	1/4	Be-Cu Al-Br	013907 026707	1/4	25	1/4	Be-Cu Al-Br	032511 036311
8	25	1/4	Be-Cu Al-Br	013908 026708	9/32	25	1/4	Be-Cu Al-Br	032514 036314
9	25	1/4	Be-Cu Al-Br	013909 026709	5/16	25	1/4	Be-Cu Al-Br	032517 036317
10	25	1/4	Be-Cu Al-Br	013910 026710	11/32	28	1/4	Be-Cu Al-Br	032520 036320
11	25	1/4	Be-Cu Al-Br	013911 026711	3/8	28	1/4	Be-Cu Al-Br	032523 036323
12	28	1/4	Be-Cu Al-Br	013912 026712	7/16	28	1/4	Be-Cu Al-Br	032526 036326
13	28	1/4	Be-Cu Al-Br	013913 026713	1/2	28	1/4	Be-Cu Al-Br	032529 036329
14	28	1/4	Be-Cu Al-Br	013914 026714					
15	27	1/4	Be-Cu Al-Br	013915 026715					
16	27	1/4	Be-Cu Al-Br	013916 026716					
17	27	1/4	Be-Cu Al-Br	013917 026717					
18	27	1/4	Be-Cu Al-Br	013918 026718					
19	27	1/4	Be-Cu Al-Br	013919 026719					



DOUILLE 3/8"



Sockets
Steckschlüsseinsätze
Cubos

S mm	L mm	C inch	Qualité	Réf
5	28	3/8	Be-Cu Al-Br	037305 037405
5.5	28	3/8	Be-Cu Al-Br	037355 037455
6	28	3/8	Be-Cu Al-Br	037306 037406
7	28	3/8	Be-Cu Al-Br	037307 037407
8	28	3/8	Be-Cu Al-Br	037308 037408
9	28	3/8	Be-Cu Al-Br	037309 037409
10	32	3/8	Be-Cu Al-Br	037310 037410
11	32	3/8	Be-Cu Al-Br	037311 037411
12	32	3/8	Be-Cu Al-Br	037312 037412
13	32	3/8	Be-Cu Al-Br	037313 037413
14	32	3/8	Be-Cu Al-Br	037314 037414
15	32	3/8	Be-Cu Al-Br	037315 037415
16	32	3/8	Be-Cu Al-Br	037316 037416
17	32	3/8	Be-Cu Al-Br	037317 037417
19	32	3/8	Be-Cu Al-Br	037319 037419
20	32	3/8	Be-Cu Al-Br	037320 037420

S inch	L mm	C inch	Qualité	Réf
5/16	32	3/8	Be-Cu Al-Br	033106 032906
3/8	32	3/8	Be-Cu Al-Br	033109 032909
7/16	32	3/8	Be-Cu Al-Br	033112 032912
1/2	32	3/8	Be-Cu Al-Br	033115 032915
9/16	32	3/8	Be-Cu Al-Br	033118 032918
5/8	35	3/8	Be-Cu Al-Br	033124 032924
11/16	35	3/8	Be-Cu Al-Br	033127 032927
3/4	35	3/8	Be-Cu Al-Br	033130 032930
13/16	35	3/8	Be-Cu Al-Br	033136 032936
7/8	35	3/8	Be-Cu Al-Br	033139 032939
15/16	35	3/8	Be-Cu Al-Br	033142 032942

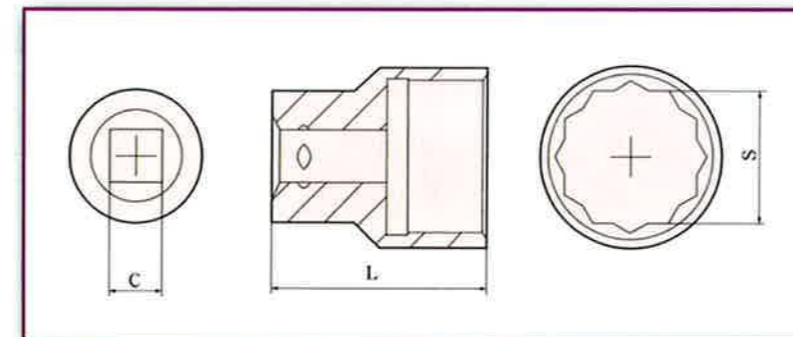

DOUILLE 1/2"

S mm	L mm	C inch	Qualité	Réf
6	40	1/2	Be-Cu Al-Br	014006 026806
7	40	1/2	Be-Cu Al-Br	014007 026807
8	40	1/2	Be-Cu Al-Br	014008 026808
9	40	1/2	Be-Cu Al-Br	014009 026809
10	40	1/2	Be-Cu Al-Br	014010 026810
11	40	1/2	Be-Cu Al-Br	014011 026811
12	40	1/2	Be-Cu Al-Br	014012 026812
13	40	1/2	Be-Cu Al-Br	014013 026813
14	40	1/2	Be-Cu Al-Br	014014 026814
15	40	1/2	Be-Cu Al-Br	014015 026815
16	40	1/2	Be-Cu Al-Br	014016 026816
17	40	1/2	Be-Cu Al-Br	014017 026817
18	42	1/2	Be-Cu Al-Br	014018 026818
19	42	1/2	Be-Cu Al-Br	014019 026819
20	42	1/2	Be-Cu Al-Br	014020 026820
21	43	1/2	Be-Cu Al-Br	014021 026821
22	43	1/2	Be-Cu Al-Br	014022 026822
23	43	1/2	Be-Cu Al-Br	014023 026823
24	43	1/2	Be-Cu Al-Br	014024 026824
25	43	1/2	Be-Cu Al-Br	014025 026825
26	43	1/2	Be-Cu Al-Br	014026 026826
27	46	1/2	Be-Cu Al-Br	014027 026827
28	46	1/2	Be-Cu Al-Br	014028 026828

S mm	L mm	C inch	Qualité	Réf
29	46	1/2	Be-Cu Al-Br	014029 026829
30	46	1/2	Be-Cu Al-Br	014030 026830
32	46	1/2	Be-Cu Al-Br	014032 026832

S inch	L mm	C inch	Qualité	Réf
5/16	40	1/2	Be-Cu Al-Br	032606 036406
3/8	40	1/2	Be-Cu Al-Br	032609 036409
7/16	40	1/2	Be-Cu Al-Br	032612 036412
1/2	40	1/2	Be-Cu Al-Br	032615 036415
9/16	40	1/2	Be-Cu Al-Br	032618 036418
5/8	40	1/2	Be-Cu Al-Br	032624 036424
11/16	40	1/2	Be-Cu Al-Br	032627 036427
3/4	42	1/2	Be-Cu Al-Br	032630 036430
13/16	43	1/2	Be-Cu Al-Br	032636 036436
7/8	43	1/2	Be-Cu Al-Br	032639 036439
15/16	43	1/2	Be-Cu Al-Br	032642 036442
1	43	1/2	Be-Cu Al-Br	032645 036445
1-1/16	46	1/2	Be-Cu Al-Br	032648 036448
1-1/4	47	1/2	Be-Cu Al-Br	032654 036454

Sockets
Steckschlüsseleinsätze
Cubos

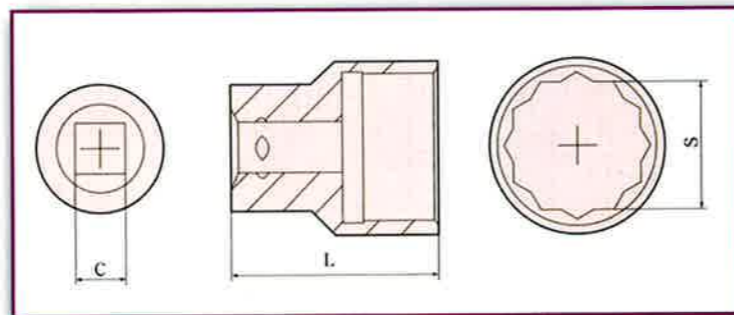

DOUILLE 3/4"

S mm	L mm	C inch	Qualité	Réf
24	55	3/4	Be-Cu Al-Br	014124 026924
26	55	3/4	Be-Cu Al-Br	014126 026926
27	55	3/4	Be-Cu Al-Br	014127 026927
28	55	3/4	Be-Cu Al-Br	014128 026928
29	55	3/4	Be-Cu Al-Br	014129 026929
30	60	3/4	Be-Cu Al-Br	014130 026930
31	60	3/4	Be-Cu Al-Br	014131 026931
32	60	3/4	Be-Cu Al-Br	014132 026932
34	60	3/4	Be-Cu Al-Br	014134 026934
36	60	3/4	Be-Cu Al-Br	014136 026936
38	60	3/4	Be-Cu Al-Br	014138 026938
41	65	3/4	Be-Cu Al-Br	014141 026941
42	65	3/4	Be-Cu Al-Br	014142 026942
46	65	3/4	Be-Cu Al-Br	014146 026946
50	70	3/4	Be-Cu Al-Br	014150 026950

S inch	L mm	C inch	Qualité	Réf
1-3/16	60	3/4	Be-Cu Al-Br	032723 036523
1-1/4	60	3/4	Be-Cu Al-Br	032726 036526
1-5/16	60	3/4	Be-Cu Al-Br	032729 036529
1-3/8	60	3/4	Be-Cu Al-Br	032732 036532
1-7/16	60	3/4	Be-Cu Al-Br	032735 036535
1-1/2	60	3/4	Be-Cu Al-Br	032738 036538
1-5/8	65	3/4	Be-Cu Al-Br	032741 036541
1-3/4	65	3/4	Be-Cu Al-Br	032744 036544
1-13/16	65	3/4	Be-Cu Al-Br	032747 036547
1-7/8	65	3/4	Be-Cu Al-Br	032750 036550
2	70	3/4	Be-Cu Al-Br	032753 036553

Sockets
Steckschlüsseleinsätze
Cubos

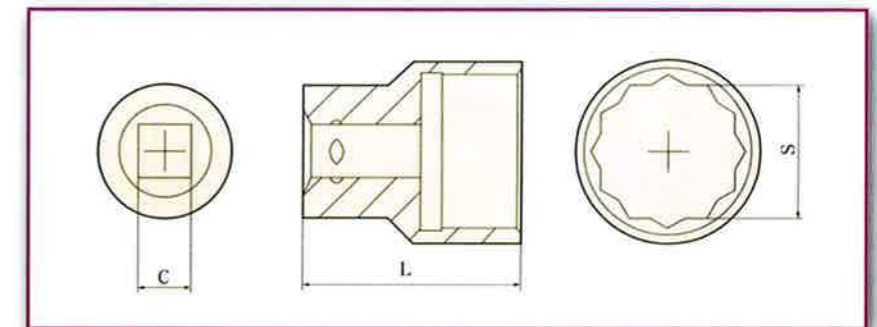

S inch	L mm	C inch	Qualité	Réf
3/4	50	3/4	Be-Cu Al-Br	032702 036502
13/16	55	3/4	Be-Cu Al-Br	032705 036505
7/8	55	3/4	Be-Cu Al-Br	032708 036508
15/16	55	3/4	Be-Cu Al-Br	032711 036511
1	55	3/4	Be-Cu Al-Br	032714 036514
1-1/16	55	3/4	Be-Cu Al-Br	032717 036517
1-1/8	55	3/4	Be-Cu Al-Br	032720 036520



DOUILLE 1"



Sockets
Steckschlüsseinsätze
Cubos

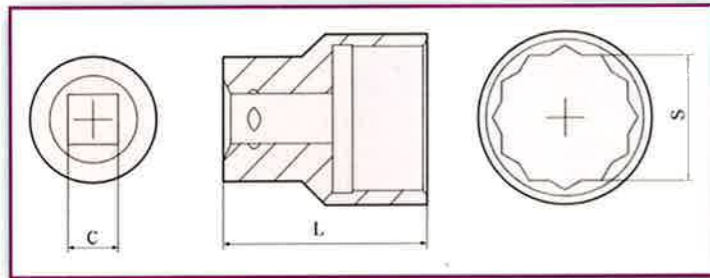

S mm	L mm	C inch	Qualité	Réf	S inch	L mm	C inch	Qualité	Réf
41	65	1	Be-Cu Al-Br	014241 027041	1-1/16	55	1	Be-Cu Al-Br	032802 033202
42	65	1	Be-Cu Al-Br	014242 027042	1-1/8	55	1	Be-Cu Al-Br	032805 033205
46	65	1	Be-Cu Al-Br	014246 027046	1-3/16	60	1	Be-Cu Al-Br	032808 033208
50	70	1	Be-Cu Al-Br	014250 027050	1-1/4	60	1	Be-Cu Al-Br	032811 033211
55	75	1	Be-Cu Al-Br	014255 027055	1-5/16	60	1	Be-Cu Al-Br	032814 033214
60	75	1	Be-Cu Al-Br	014260 027060	1-3/8	60	1	Be-Cu Al-Br	032817 033217
65	80	1	Be-Cu Al-Br	014265 027065	1-7/16	60	1	Be-Cu Al-Br	032820 033220
70	80	1	Be-Cu Al-Br	014270 027070	1-1/2	60	1	Be-Cu Al-Br	032823 033223
75	85	1	Be-Cu Al-Br	014275 027075	1-5/8	65	1	Be-Cu Al-Br	032826 033226
80	85	1	Be-Cu Al-Br	014280 027080	1-7/8	65	1	Be-Cu Al-Br	032829 033229
85	90	1	Be-Cu Al-Br	014285 027085	2	70	1	Be-Cu Al-Br	032832 033232
90	90	1	Be-Cu Al-Br	014290 027290	2-1/4	75	1	Be-Cu Al-Br	032835 033235
95	90	1	Be-Cu Al-Br	014295 027095	2-1/2	75	1	Be-Cu Al-Br	032838 033238
100	90	1	Be-Cu Al-Br	014299 027099	2-3/4	80	1	Be-Cu Al-Br	032841 033241
					3	80	1	Be-Cu Al-Br	032844 033244



Ex **LAMPE PNEUMATIQUE**
PNEUMATIC LAMP

Sur demande
On request.

acb.adf@wanadoo.fr

DOUILLE 3/4" Série IMPACT



Impact sockets
Schlagschraubereinsätze
Cubos Impact

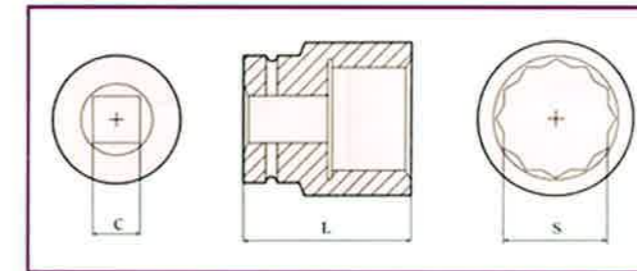

S mm	L mm	C inch	Qualité	Réf
24	55	3/4	Be-Cu Al-Br	033524 039124
27	55	3/4	Be-Cu Al-Br	033527 039127
30	60	3/4	Be-Cu Al-Br	033530 039130
32	60	3/4	Be-Cu Al-Br	033532 039132
36	60	3/4	Be-Cu Al-Br	033536 039136
41	65	3/4	Be-Cu Al-Br	033541 039141
46	65	3/4	Be-Cu Al-Br	033546 039146
50	70	3/4	Be-Cu Al-Br	033550 039150

DOUILLE 1" Série IMPACT

S mm	L mm	C inch	Qualité	Réf	S mm	L mm	C inch	Qualité	Réf
19	60	1	Be-Cu Al-Br	033619 039219	38	70	1	Be-Cu Al-Br	033638 039238
21	60	1	Be-Cu Al-Br	033621 039221	41	70	1	Be-Cu Al-Br	033641 039241
22	60	1	Be-Cu Al-Br	033622 039222	46	80	1	Be-Cu Al-Br	033646 039246
24	60	1	Be-Cu Al-Br	033624 039224	50	80	1	Be-Cu Al-Br	033650 039250
26	60	1	Be-Cu Al-Br	033626 039226	52	90	1	Be-Cu Al-Br	033652 039252
27	60	1	Be-Cu Al-Br	033627 039227	55	90	1	Be-Cu Al-Br	033655 039255
29	60	1	Be-Cu Al-Br	033629 039229	58	90	1	Be-Cu Al-Br	033658 039258
30	60	1	Be-Cu Al-Br	033630 039230	60	90	1	Be-Cu Al-Br	033660 039260
32	60	1	Be-Cu Al-Br	033632 039232	65	90	1	Be-Cu Al-Br	033665 039265
34	70	1	Be-Cu Al-Br	033634 039234	70	90	1	Be-Cu Al-Br	033670 039270
35	70	1	Be-Cu Al-Br	033635 039235	75	90	1	Be-Cu Al-Br	033675 039275
36	70	1	Be-Cu Al-Br	033636 039236	80	90	1	Be-Cu Al-Br	033680 039280



Impact sockets
Schlagschraubereinsätze
Cubos Impact

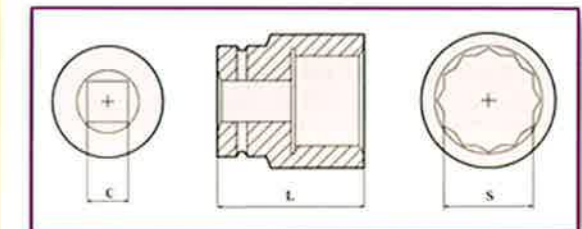

CLIQUET REVERSIBLE

C inch	L mm	Qualité	Réf
1/4	125	Be-Cu Al-Br	013700 028500
3/8	125	Be-Cu Al-Br	013701 028501
1/2	245	Be-Cu Al-Br	013702 028502
3/4	300	Be-Cu Al-Br	013703 028503
1	550	Be-Cu Al-Br	013705 028505



Ratchet
Knarre
Llave Trinquete

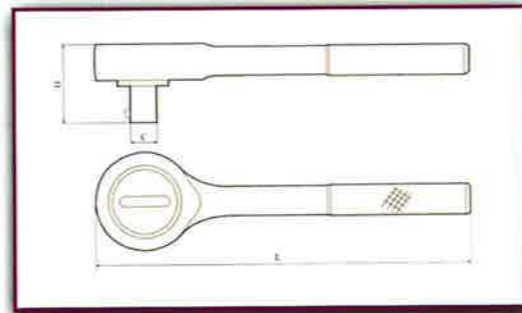

CLIQUET REVERSIBLE



Ratchet
Knarre
Llave Trinquete

C inch	L mm	H mm	Qualité	Réf
3/4	160	63	Be-Cu Al-Br	077903 082303
1	180	80	Be-Cu Al-Br	077905 082305

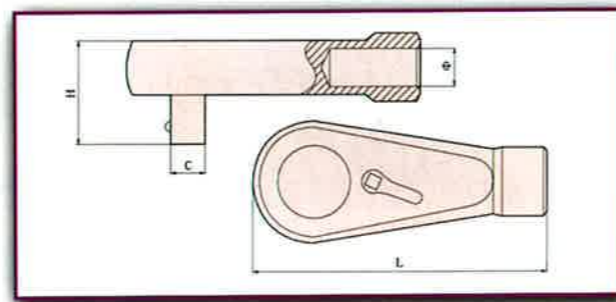

*Avec manche
With handle

CLIQUET REVERSIBLE

C inch	L mm	Qualité	Réf
1/4	200	Be-Cu Al-Br	078002 082402
3/8	200	Be-Cu Al-Br	078006 082406
1/2	250	Be-Cu Al-Br	078008 082408
3/4	300	Be-Cu Al-Br	078010 082410
1	300	Be-Cu Al-Br	078012 082412



Ratchet
Knarre
Llave Trinquete

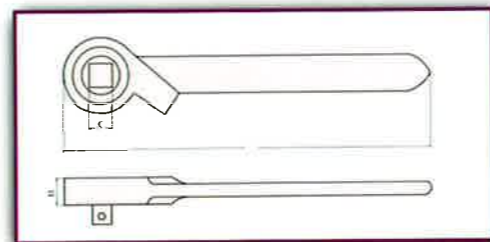

POIGNEE ARTICULEE

C inch	L mm	L1 mm	Qualité	Réf
1/4	190	175	Be-Cu Al-Br	014500 027300
3/8	195	175	Be-Cu Al-Br	014501 027301
1/2	328	300	Be-Cu Al-Br	014502 027302
3/4	295	260	Be-Cu Al-Br	014503 027303
1	315	270	Be-Cu Al-Br	014504 027304



Hinged handle
Gelenkgriff
Mango de Cabeza Deslizante

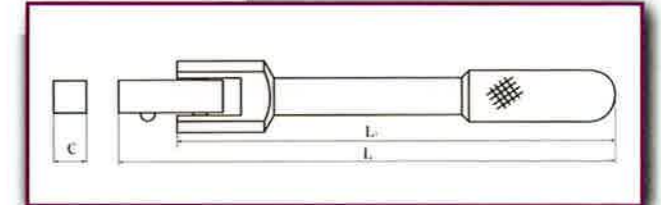

POIGNEE COUDEE



Offset handle
Winkelgriff
Mango acollado

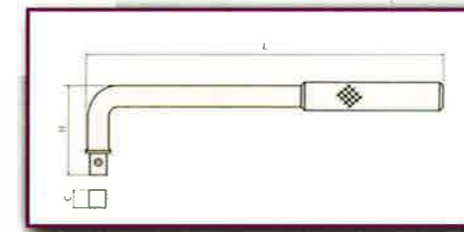

C inch	L mm	Qualité	Réf
1/4	200	Be-Cu Al-Br	014700 027500
1/2	230	Be-Cu Al-Br	014702 027502
3/4	280	Be-Cu Al-Br	014703 027503
1	300	Be-Cu Al-Br	014704 027504

VILEBREQUIN



Speed handle
Winde
Manivela

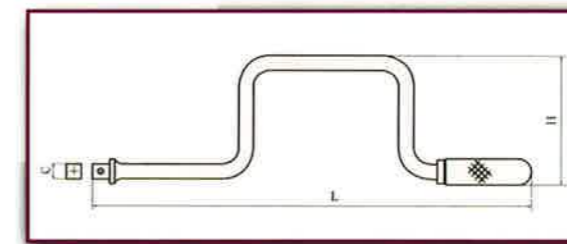

C inch	L mm	Qualité	Réf
1/4	300	Be-Cu Al-Br	014400 027200
3/8	300	Be-Cu Al-Br	014401 027201
1/2	390	Be-Cu Al-Br	014402 027202

RALLONGE



Extension bar
Verlängerungen
Barra de Extension

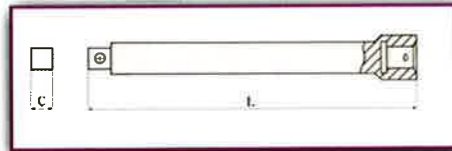

C inch	L mm	Qualité	Réf	C inch	L mm	Qualité	Réf
1/4	200	Be-Cu Al-Br	014305 027105	1/2	200	Be-Cu Al-Br	014314 027114
3/8	75	Be-Cu Al-Br	014308 027108	1/2	250	Be-Cu Al-Br	014318 027118
3/8	150	Be-Cu Al-Br	014309 027109	3/4	200	Be-Cu Al-Br	014320 027120
1/2	100	Be-Cu Al-Br	014312 027112	1	200	Be-Cu Al-Br	014325 027125
1/2	125	Be-Cu Al-Br	014313 027113				

POIGNEE COULISSANTE



Sliding T bar
T - Gleitgriff
Barra Deslizante

C inch	L mm	H mm	Ø mm	Qualité	Réf
1/2	250	39	13	Be-Cu Al-Br	013802 026802
3/4	350	54	19	Be-Cu Al-Br	013803 026803
1	400	62	21	Be-Cu Al-Br	013804 026804

TOURNEVIS POUR DOUILLE 1/4"



Spinner handle
Steckgriff
Atornillador

C inch	L mm	L1 mm	D mm	Qualité	Réf
1/4	140	55	23	Be-Cu Al-Br	079802 084002

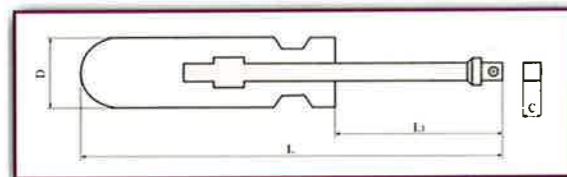

CARDAN UNIVERSEL



Universal joint
Kardangelnk
Conexion Universal

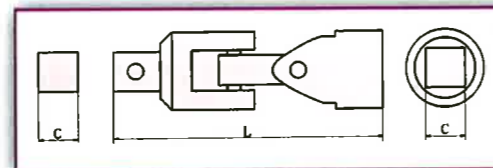

C inch	L mm	Qualité	Réf
1/2	50	Be-Cu Al-Br	014802 027402
3/4	100	Be-Cu Al-Br	014803 027403
1	115	Be-Cu Al-Br	014804 027404

MANCHE A CLIQUET



Ratchet wrench
Schaltklinke
Llave del trinquete

S mm	L mm	H mm	Qualité	Réf
38	320	65	Be-Cu Al-Br	013738 026538
41	330	70	Be-Cu Al-Br	013741 026541

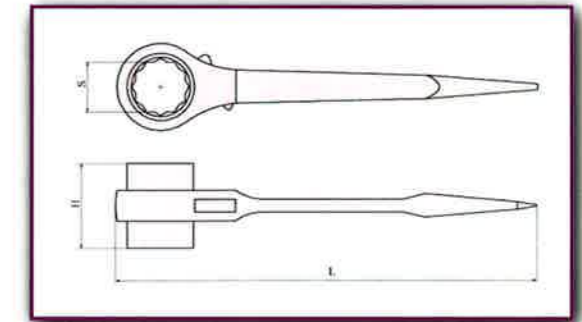

MANCHE A CLIQUET



Ratchet wrench
Schaltklinke
Llave del trinquete

S mm	L mm	H mm	Qualité	Réf
19	300	35	Be-Cu Al-Br	013719 026519
24	329	39	Be-Cu Al-Br	013724 026524
30	433	42	Be-Cu Al-Br	013730 026530
32	435	42	Be-Cu Al-Br	013732 026532
36	487	43	Be-Cu Al-Br	013736 026536

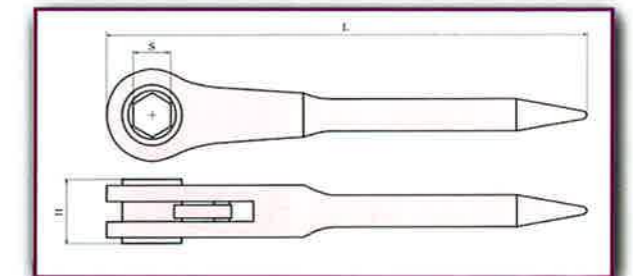

CLE DYNAMOMETRIQUE

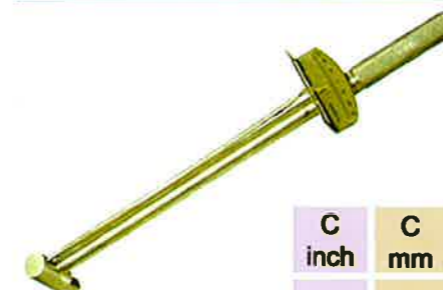

Torque wrench
Drehmomentschlüssel
Dinamometricas de disparo

C inch	C mm	L mm	Qualité	Réf
1/2	12.7	490	Be-Cu Al-Br	029301 029302

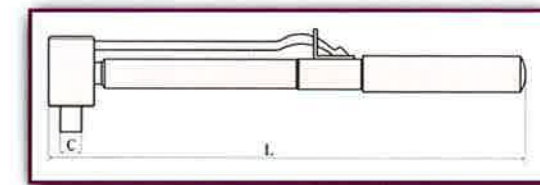

CLE A FOURCHE SIMPLE

S mm	L mm	Qualité	Réf	S mm	L mm	Qualité	Réf
6	83	Be-Cu Al-Br	005106 019906	46	350	Be-Cu Al-Br	005146 019946
7	87	Be-Cu Al-Br	005107 019907	48	362	Be-Cu Al-Br	005148 019948
8	92	Be-Cu Al-Br	005108 019908	50	375	Be-Cu Al-Br	005150 019950
9	97	Be-Cu Al-Br	005109 019909	55	400	Be-Cu Al-Br	005155 019955
10	102	Be-Cu Al-Br	005110 019910	60	425	Be-Cu Al-Br	005160 019960
11	107	Be-Cu Al-Br	005111 019911	65	450	Be-Cu Al-Br	005165 019965
14	124	Be-Cu Al-Br	005114 019914	70	475	Be-Cu Al-Br	005170 019970
17	143	Be-Cu Al-Br	005117 019917	75	500	Be-Cu Al-Br	005175 019975
19	157	Be-Cu Al-Br	005119 019919				
20	164	Be-Cu Al-Br	005120 019920				
21	171	Be-Cu Al-Br	005121 019921				
22	180	Be-Cu Al-Br	005122 019922				
23	188	Be-Cu Al-Br	005123 019923				
24	196	Be-Cu Al-Br	005124 019924				
27	225	Be-Cu Al-Br	005127 019927				
30	255	Be-Cu Al-Br	005130 019930				
32	275	Be-Cu Al-Br	005132 019932				
34	285	Be-Cu Al-Br	005134 019934				
36	300	Be-Cu Al-Br	005136 019936				
39	315	Be-Cu Al-Br	005139 019939				
41	325	Be-Cu Al-Br	005141 019941				
42	330	Be-Cu Al-Br	005142 019942				



Single open end wrench
Einfachmaulschlüssel, DIN 894
Llave de Boca Sencilla

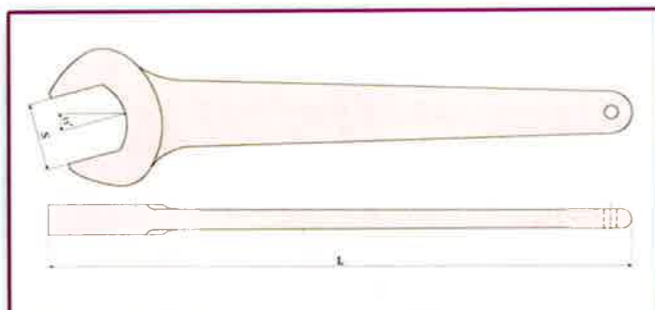

CLE POLYGONALE SIMPLE

S mm	L mm	Qualité	Réf	S mm	L mm	Qualité	Réf
8	100	Be-Cu Al-Br	004908 019708	21	183	Be-Cu Al-Br	004921 019721
10	110	Be-Cu Al-Br	004910 019710	22	190	Be-Cu Al-Br	004922 019722
12	120	Be-Cu Al-Br	004912 019712	24	210	Be-Cu Al-Br	004924 019724
14	130	Be-Cu Al-Br	004914 019714	27	230	Be-Cu Al-Br	004927 019727
16	143	Be-Cu Al-Br	004916 019716	30	250	Be-Cu Al-Br	004930 019730
17	150	Be-Cu Al-Br	004917 019717	32	270	Be-Cu Al-Br	004932 019732
18	160	Be-Cu Al-Br	004918 019718	34	280	Be-Cu Al-Br	004934 019734
19	170	Be-Cu Al-Br	004919 019719	36	290	Be-Cu Al-Br	004936 019736
20	176	Be-Cu Al-Br	004920 019720	38	298	Be-Cu Al-Br	004938 019738
				41	310	Be-Cu Al-Br	004941 019741
				45	326	Be-Cu Al-Br	004945 019745
				46	330	Be-Cu Al-Br	004946 019746
				48	340	Be-Cu Al-Br	004948 019748
				50	350	Be-Cu Al-Br	004950 019750
				55	370	Be-Cu Al-Br	004955 019755
				56	374	Be-Cu Al-Br	004956 019756
				60	390	Be-Cu Al-Br	004960 019760
				65	410	Be-Cu Al-Br	004965 019765
				70	430	Be-Cu Al-Br	004970 019770
				75	450	Be-Cu Al-Br	004975 019775
				80	470	Be-Cu Al-Br	004980 019780
				85	490	Be-Cu Al-Br	004985 019785



Single end box wrench
Einfachringschlüssel, DIN 3111
Llave de Cajon Sencilla

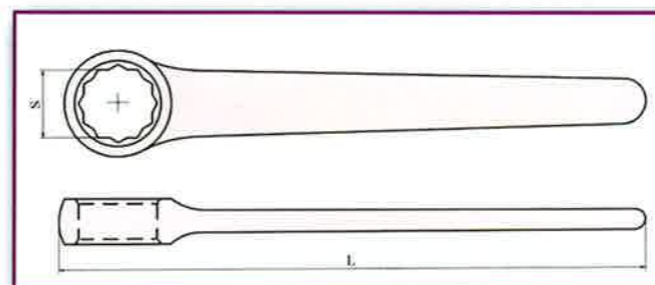

CLE MIXTE

S mm	L mm	Qualité	Réf	S mm	L mm	Qualité	Réf
6	115	Be-Cu Al-Br	005406 020208	28	300	Be-Cu Al-Br	005428 020228
7	120	Be-Cu Al-Br	005407 020207	29	300	Be-Cu Al-Br	005429 020229
8	125	Be-Cu Al-Br	005408 020208	30	310	Be-Cu Al-Br	005430 020230
9	130	Be-Cu Al-Br	005409 020209	31	320	Be-Cu Al-Br	005431 020231
10	135	Be-Cu Al-Br	005410 020210	32	330	Be-Cu Al-Br	005432 020232
11	135	Be-Cu Al-Br	005411 020211	34	337	Be-Cu Al-Br	005434 020234
12	140	Be-Cu Al-Br	005412 020212	35	337	Be-Cu Al-Br	005435 020235
13	155	Be-Cu Al-Br	005413 020213	36	350	Be-Cu Al-Br	005436 020236
14	165	Be-Cu Al-Br	005414 020214	38	360	Be-Cu Al-Br	005438 020238
15	175	Be-Cu Al-Br	005415 020215	40	360	Be-Cu Al-Br	005440 020240
16	185	Be-Cu Al-Br	005416 020216	41	370	Be-Cu Al-Br	005441 020241
17	195	Be-Cu Al-Br	005417 020217	46	405	Be-Cu Al-Br	005446 020246
18	205	Be-Cu Al-Br	005418 020218	50	420	Be-Cu Al-Br	005450 020250
19	215	Be-Cu Al-Br	005419 020219	55	435	Be-Cu Al-Br	005455 020255
20	225	Be-Cu Al-Br	005420 020220	60	462	Be-Cu Al-Br	005460 020260
21	235	Be-Cu Al-Br	005421 020221	65	470	Be-Cu Al-Br	005465 020265
22	245	Be-Cu Al-Br	005422 020222	70	480	Be-Cu Al-Br	005470 020270
23	255	Be-Cu Al-Br	005423 020223	75	490	Be-Cu Al-Br	005475 020275
24	265	Be-Cu Al-Br	005424 020224	80	500	Be-Cu Al-Br	005480 020280
25	270	Be-Cu Al-Br	005425 020225	85	515	Be-Cu Al-Br	005485 020285
26	275	Be-Cu Al-Br	005426 020226	90	525	Be-Cu Al-Br	005490 020290
27	285	Be-Cu Al-Br	005427 020227				



Combination wrench
Ringmaulschlüssel, DIN 3113
Llave Combinada

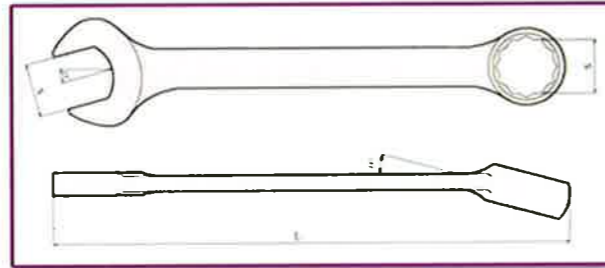

CLE MIXTE

S inch	L mm	Qualité	Réf	S inch	L mm	Qualité	Réf
1/4	115	Be-Cu Al-Br	031303 035103	13/16	230	Be-Cu Al-Br	031328 035128
5/16	123	Be-Cu Al-Br	031306 035106	7/8	235	Be-Cu Al-Br	031330 035130
3/8	128	Be-Cu Al-Br	031309 035109	15/16	256	Be-Cu Al-Br	031331 035131
7/16	135	Be-Cu Al-Br	031312 035112	1	266	Be-Cu Al-Br	031333 035133
1/2	140	Be-Cu Al-Br	031315 035115	1-1/16	283	Be-Cu Al-Br	031336 035136
9/16	163	Be-Cu Al-Br	031318 035118	1-1/8	297	Be-Cu Al-Br	031339 035139
19/32	173	Be-Cu Al-Br	031319 035119	1-3/16	305	Be-Cu Al-Br	031340 035140
5/8	177	Be-Cu Al-Br	031321 035121	1-1/4	324	Be-Cu Al-Br	031342 035142
11/16	195	Be-Cu Al-Br	031324 035124	1-5/16	355	Be-Cu Al-Br	031345 035145
3/4	215	Be-Cu Al-Br	031327 035127	1-3/8	385	Be-Cu Al-Br	031348 035148



Combination wrench
Ringmaulschlüssel DIN 3113
Llave Combinada

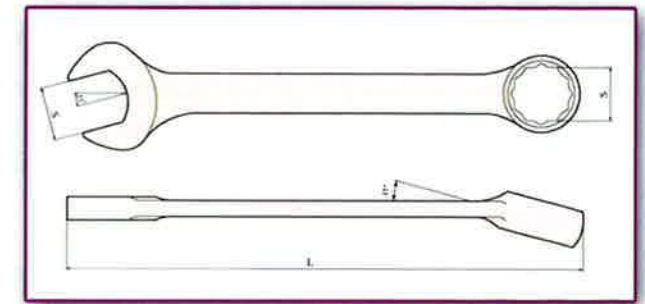

CLE A MOLETTE



Adjustable end wrench
Rollgabelschlüssel
Llave de Cabeza Ajustable

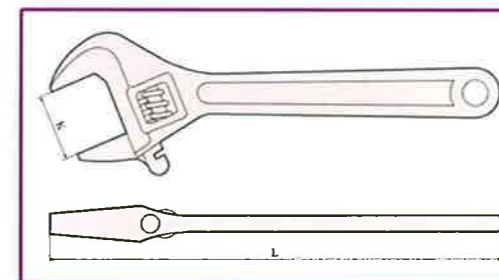

L mm	L inch	K min	Qualité	Réf
100	4"	13	Be-Cu Al-Br	009407 023607
150	6"	18	Be-Cu Al-Br	009408 023608
200	8"	24	Be-Cu Al-Br	009409 023609
250	10"	30	Be-Cu Al-Br	009412 023612
300	12"	36	Be-Cu Al-Br	009416 023616
375	15"	46	Be-Cu Al-Br	009420 023620
450	18"	55	Be-Cu Al-Br	009423 023623
600	24"	65	Be-Cu Al-Br	009426 023626



CLE MIXTE - JEU DE 9 PIECES

Combination wrench, sets
Ringmaulschlüssel Sätze
Liave Combinada, luego

S mm	Qualité	Réf
8,10,12,14,17,19,22,24,27	Be-cu Al-br	037609 037709



CLE MIXTE - JEU DE 11 PIECES

Combination wrench, sets
Ringmaulschlüssel Sätze
Liave Combinada, luego

S mm	Qualité	Réf
8,10,12,14,17,19,22,24,27,30,32	Be-Cu Al-Br	037611 037711



CLE MIXTE - JEU DE 13 PIECES

Combination wrench, sets
Ringmaulschlüssel Sätze
Liave Combinada, luego

S mm	Qualité	Réf
8,10,12,13,14,16,17,19,22,24,27,30,32	Be-Cu Al-Br	037613 037713



CLE A FOURCHE DOUBLE

S1*S2 mm	L mm	Qualité	Réf	S1*S2 mm	L mm	Qualité	Réf
6*7	92	Be-Cu Al-Br	004805 019605	25*28	236	Be-Cu Al-Br	004864 019664
8*9	98	Be-Cu Al-Br	004809 019609	27*30	250	Be-Cu Al-Br	004869 019669
10*11	115	Be-Cu Al-Br	004818 019618	20*32	265	Be-Cu Al-Br	004873 019673
12*13	128	Be-Cu Al-Br	004825 019625	32*36	290	Be-Cu Al-Br	004877 019677
14*15	143	Be-Cu Al-Br	004829 019629	36*41	335	Be-Cu Al-Br	004882 019682
16*17	157	Be-Cu Al-Br	004833 019633	41*46	355	Be-Cu Al-Br	004884 019684
17*19	170	Be-Cu Al-Br	004838 019638	46*50	370	Be-Cu Al-Br	004886 019686
18*19	179	Be-Cu Al-Br	004842 019642	50*55	385	Be-Cu Al-Br	004888 019688
20*22	195	Be-Cu Al-Br	004849 019649	55*60	415	Be-Cu Al-Br	004893 019693
21*23	200	Be-Cu Al-Br	004851 019651	65*70	460	Be-Cu Al-Br	004897 019697
22*24	210	Be-Cu Al-Br	004853 019653	70*80	520	Be-Cu Al-Br	004899 019699
24*27	230	Be-Cu Al-Br	004860 019660				



Double open end wrench
Doppelmaulschl, DIN 895
Liave de Boca Doble

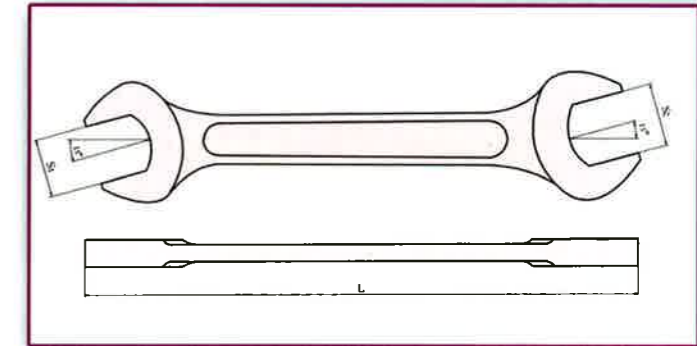

CLE A FOURCHE DOUBLE

S1*S2 inch	L mm	Qualité	Réf	S1*S2 inch	L mm	Qualité	Réf
7/32*1/4	90	Be-Cu Al-Br	030703 034503	1-1/2*1-9/16	350	Be-Cu Al-Br	030818 034618
1/4*5/16	90	Be-Cu Al-Br	030706 034506	1-5/8*1-13/16	355	Be-Cu Al-Br	030821 034621
5/16*3/8	100	Be-Cu Al-Br	030709 034509	1-13/16*2	370	Be-Cu Al-Br	030830 034630
3/8*7/16	110	Be-Cu Al-Br	030712 034512	2*2-3/16	385	Be-Cu Al-Br	030833 034633
3/8*1/2	115	Be-Cu Al-Br	030713 034513	2*2-3/8	400	Be-Cu Al-Br	030836 034636
7/16*1/2	120	Be-Cu Al-Br	030715 034515	2-3/16*2-3/8	415	Be-Cu Al-Br	030839 034639
1/2*9/16	130	Be-Cu Al-Br	030721 034521	2-3/8*2-9/16	435	Be-Cu Al-Br	030842 034642
9/16*5/8	150	Be-Cu Al-Br	030727 034527				
5/8*11/16	160	Be-Cu Al-Br	030739 034539				
5/8*3/4	165	Be-Cu Al-Br	030742 034542				
11/16*3/4	170	Be-Cu Al-Br	030745 034545				
3/4*13/16	180	Be-Cu Al-Br	030754 034554				
3/4*7/8	185	Be-Cu Al-Br	030757 034557				
13/16*7/8	190	Be-Cu Al-Br	030766 034566				
7/8*15/16	210	Be-Cu Al-Br	030769 034569				
15/16*1	220	Be-Cu Al-Br	030781 034581				
1*1-1/16	230	Be-Cu Al-Br	030790 034590				
1-1/16*1-1/8	235	Be-Cu Al-Br	030793 034593				
1-1/8*1-3/16	245	Be-Cu Al-Br	030796 034596				
1-1/4*1-5/16	260	Be-Cu Al-Br	030806 034606				
1-5/16*1-3/8	295	Be-Cu Al-Br	030809 034609				
1-3/8*1-7/16	320	Be-Cu Al-Br	030812 034612				
1-7/16*1-5/8	335	Be-Cu Al-Br	030815 034615				



**Double open end wrench
Doppelmaulschl, DIN 895
Llave de Boca Doble**

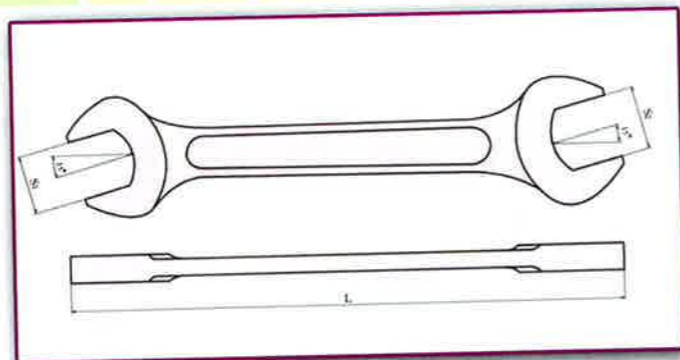

CLE A FOURCHE DOUBLE - JEU DE 9 PIECES

**Double open end wrench
Doppelmaulschlüssel, DIN 895
Llave de Boca Doble**

S1*S2 mm	Qualité	Réf
8*10,10*12,12*14, 14*17,17*19,19*22, 22*24,24*27,30*32	Be-Cu Al-br	037809 037909



CLE A FOURCHE DOUBLE - JEU DE 11 PIECES

**Double open end wrench
Doppelmaulschlüssel, DIN 895
Llave de Boca Doble**

S1*S2 mm	Qualité	Réf
8*10,9*11,10*12, 12*14,14*17,17*19, 19*22,22*24,24*27, 27*30,30*32	Be-Cu Al-Br	037811 037911



CLE A FOURCHE DOUBLE - JEU DE 13 PIECES

**Double open end wrench
Doppelmaulschlüssel, DIN 895
Llave de Boca Doble**

S1*S2 mm	Qualité	Réf
5.5*7,8*7,8*10,9*11, 10*12,12*14,14*17, 17*19,19*22,22*24, 24*27,27*30,30*32	Be-Cu Al-Br	037813 037913



CLE POLYGONALE CONTRE-COUEDE

S1*S2 mm	L mm	Qualité	Réf	S1*S2 mm	L mm	Qualité	Réf
6*7	122	Be-Cu Al-Br	004705 019505	27*30	360	Be-Cu Al-Br	004771 019571
8*9	128	Be-Cu Al-Br	004711 019511	29*32	373	Be-Cu Al-Br	004774 019574
10*11	150	Be-Cu Al-Br	004720 019520	30*32	380	Be-Cu Al-Br	004775 019575
12*13	176	Be-Cu Al-Br	004727 019527	30*36	395	Be-Cu Al-Br	004777 019577
14*15	200	Be-Cu Al-Br	004731 019531	32*36	410	Be-Cu Al-Br	004779 019579
16*17	230	Be-Cu Al-Br	004735 019535	36*38	434	Be-Cu Al-Br	004781 019581
17*19	250	Be-Cu Al-Br	004740 019540	36*41	450	Be-Cu Al-Br	004783 019583
18*19	268	Be-Cu Al-Br	004744 019544	41*46	470	Be-Cu Al-Br	004785 019585
20*22	292	Be-Cu Al-Br	004751 019551	46*50	490	Be-Cu Al-Br	004787 019587
21*23	298	Be-Cu Al-Br	004753 019553	50*55	510	Be-Cu Al-Br	004789 019589
24*26	333	Be-Cu Al-Br	004760 019560	50*60	520	Be-Cu Al-Br	004791 019591
25*28	346	Be-Cu Al-Br	004766 019566	55*60	530	Be-Cu Al-Br	004793 019593



Double end box wrench offset
Doppelringsschlüssel gekröpft, DIN 838
Llave de Cajon Doble tipo acodado

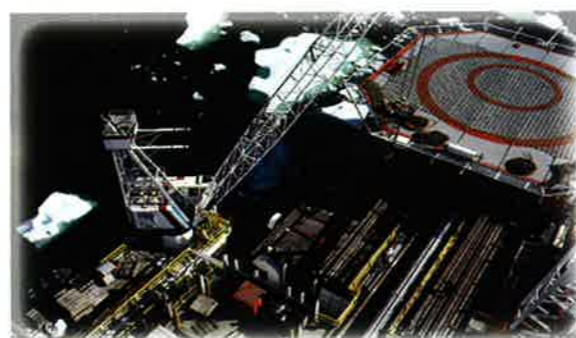
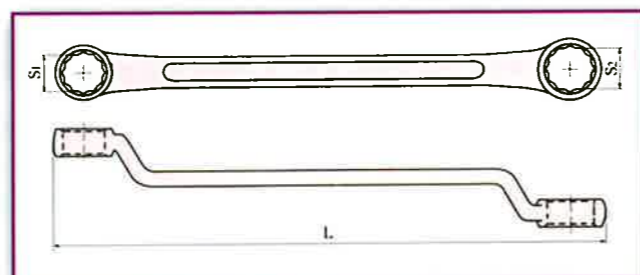

CLE DE BOUTEILLE D' OXYGENE

C inch	L mm	H mm	Qualité	Réf
3/8	154	40	Be-Cu Al-Br	078903 083303

Oxygen Bottle Wrench
Sauerstoffschlüssel
Llave de la botella de oxígeno

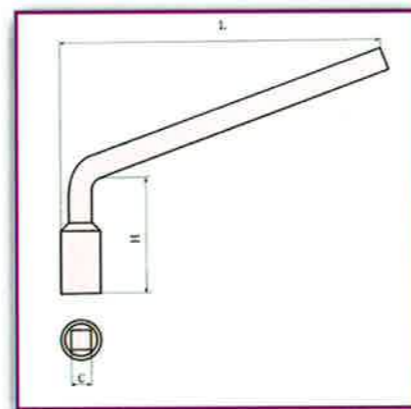

CLE POLYGONALE CONTRE-COUEDE



Double end box wrench offset
Doppelringschlüssel gekröpft, DIN 838
Llave de Cajon Doble tipo acodado

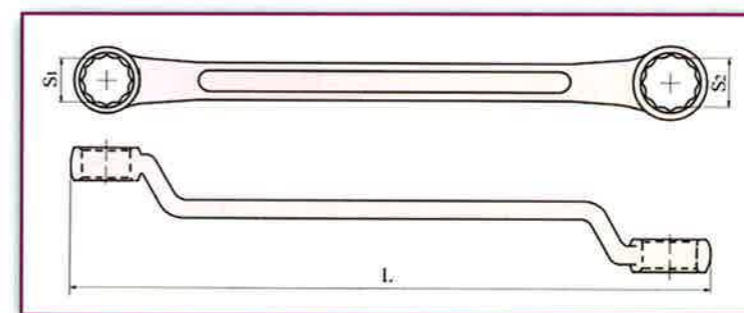

S1*S2 inch	L mm	Qualité	Réf
1/4*5/16	115	Be-Cu Al-Br	030606 034406
5/16*3/8	125	Be-Cu Al-Br	030609 034409
3/8*7/16	140	Be-Cu Al-Br	030612 034412
7/16*1/2	155	Be-Cu Al-Br	030615 034415



S1*S2 inch	L mm	Qualité	Réf
1/2*9/16	175	Be-Cu Al-Br	030618 034418
9/16*5/8	215	Be-Cu Al-Br	030624 034424
5/8*11/16	220	Be-Cu Al-Br	030626 034426
11/16*3/4	245	Be-Cu Al-Br	030631 034431
3/4*13/16	255	Be-Cu Al-Br	030634 034434
13/16*7/8	275	Be-Cu Al-Br	030636 034436
7/8*15/16	305	Be-Cu Al-Br	030640 034440
15/16*1	310	Be-Cu Al-Br	030648 034448
1*1-1/16	330	Be-Cu Al-Br	030653 034453
1-1/16*1-1/8	330	Be-Cu Al-Br	030657 034457
1-1/8*1-3/16	370	Be-Cu Al-Br	030662 034462
1-3/16*1-1/4	370	Be-Cu Al-Br	030664 034464
1-1/4*1-5/16	380	Be-Cu Al-Br	030666 034466
1-5/16*1-3/8	410	Be-Cu Al-Br	030670 034470
1-3/8*1-7/16	410	Be-Cu Al-Br	030671 034471
1-7/16*1-5/8	450	Be-Cu Al-Br	030672 034472
1-1/2*1-9/16	460	Be-Cu Al-Br	030673 034473
1-5/8*1-13/16	470	Be-Cu Al-Br	030675 034475
1-13/16*2	490	Be-Cu Al-Br	030678 034478
2*2-3/16	510	Be-Cu Al-Br	030683 034483
2*2-3/8	520	Be-Cu Al-Br	030684 034484
2-3/16*2-3/8	530	Be-Cu Al-Br	030685 034485
2-3/8*2-3/4	560	Be-Cu Al-Br	030689 034489

CLE POLYGONALE DOUBLE COUDEE - JEU DE 9 PIECES

Double end box wrench offset, sets
Doppelringschlüssel-Sätze, gekröpft
Llave de Cajon Doble tipo acodado, juego

S1*S2 mm	Qualité	Réf
8*10,10*12,12*14, 14*17,17*19,19*22, 22*24,24*27,30*32	Be-cu Al-br	038809 038709



CLE POLYGONALE DOUBLE COUDEE - JEU DE 11 PIECES

Double end box wrench offset, sets
Doppelringschlüssel-Sätze, gekröpft
Llave de Cajon Doble tipo acodado, juego

S1*S2 mm	Qualité	Réf
8*10,9*11,10*12, 12*14,14*17,17*19, 19*22,22*24,24*27, 27*30,30*32	Be-Cu Al-Br	038811 038711



CLE POLYGONALE DOUBLE COUDEE - JEU DE 13 PIECES

Double end box wrench offset, sets
Doppelringschlüssel-Sätze, gekröpft
Llave de Cajon Doble tipo acodado, juego

S1*S2 mm	Qualité	Réf
5.5*7,6*7,8*10,9*11, 10*12,12*14,14*17, 17*19,19*22,22*24, 24*27,27*30,30*32	Be-Cu Al-Br	038813 038713



CLE MÂLE 6 PANS

Hex key /Allen key
Sechskant-Winkelschraubendreher
(Inbus) DIN 911
Llave Hexagonal Allen

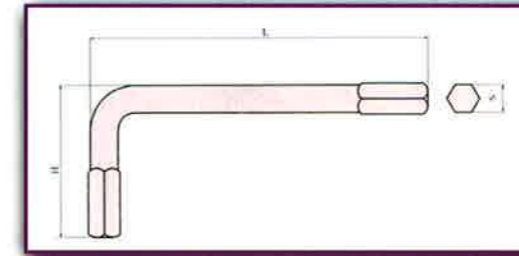

S mm	L mm	H mm	Qualité	Réf	S inch	L mm	H mm	Qualité	Réf	S inch	L mm	H mm	Qualité	Réf
1.5	38	13	Be-Cu Al-Br	006201 021001	1/16	38	13	Be-Cu Al-Br	031597 035397	1/2	140	55	Be-Cu Al-Br	031530 035330
2	38	13	Be-Cu Al-Br	006202 021002	5/64	38	13	Be-Cu Al-Br	031598 035398	9/16	150	58	Be-Cu Al-Br	031533 035333
2.5	38	13	Be-Cu Al-Br	006200 021000	3/32	38	13	Be-Cu Al-Br	031599 035399	5/8	162	63	Be-Cu Al-Br	031536 035336
3	59	25	Be-Cu Al-Br	006203 021003	7/64	58	24	Be-Cu Al-Br	031502 035302	11/16	168	65	Be-Cu Al-Br	031539 035339
4	65	30	Be-Cu Al-Br	006204 021004	1/8	58	24	Be-Cu Al-Br	031503 035303	3/4	178	73	Be-Cu Al-Br	031542 035342
5	79	32	Be-Cu Al-Br	006205 021005	9/64	64	29	Be-Cu Al-Br	031506 035306	13/16	184	77	Be-Cu Al-Br	031544 035344
6	85	37	Be-Cu Al-Br	006206 021006	5/32	65	30	Be-Cu Al-Br	031509 035309	7/8	187	79	Be-Cu Al-Br	031545 035345
7	88	43	Be-Cu Al-Br	006207 021007	3/16	79	31	Be-Cu Al-Br	031512 035312	15/16	192	82	Be-Cu Al-Br	031547 035347
8	92	44	Be-Cu Al-Br	006208 021008	7/32	85	37	Be-Cu Al-Br	031515 035315	1	200	85	Be-Cu Al-Br	031548 035348
9	97	44	Be-Cu Al-Br	006209 021009	1/4	85	37	Be-Cu Al-Br	031518 035318	1-1/16	213	93	Be-Cu Al-Br	031551 035351
10	110	45	Be-Cu Al-Br	006210 021010	9/32	88	43	Be-Cu Al-Br	031519 035319	1-1/8	222	95	Be-Cu Al-Br	031554 035354
11	119	48	Be-Cu Al-Br	006211 021011	5/16	92	44	Be-Cu Al-Br	031521 035321	1-3/16	240	105	Be-Cu Al-Br	031555 035355
12	130	52	Be-Cu Al-Br	006212 021012	11/32	97	44	Be-Cu Al-Br	031522 035322	1-1/4	266	116	Be-Cu Al-Br	031557 035357
13	140	54	Be-Cu Al-Br	006213 021013	3/8	110	45	Be-Cu Al-Br	031524 035324	1-7/16	294	128	Be-Cu Al-Br	031566 035366
14	150	58	Be-Cu Al-Br	006214 021014	7/16	119	48	Be-Cu Al-Br	031527 035327	1-5/8	320	140	Be-Cu Al-Br	031572 035372
15	156	60	Be-Cu Al-Br	006215 021015										
16	162	63	Be-Cu Al-Br	006216 021016										



CLE A VANNE

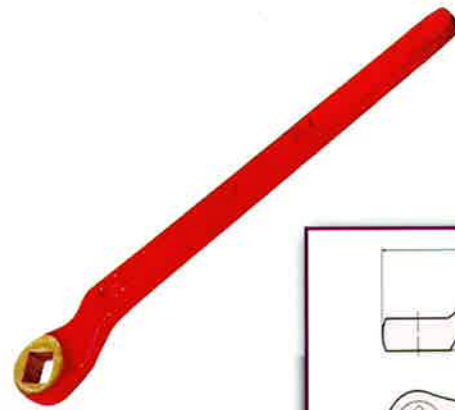

Key has valve
Schlüssel hat scheiber
La llave tiene valvula

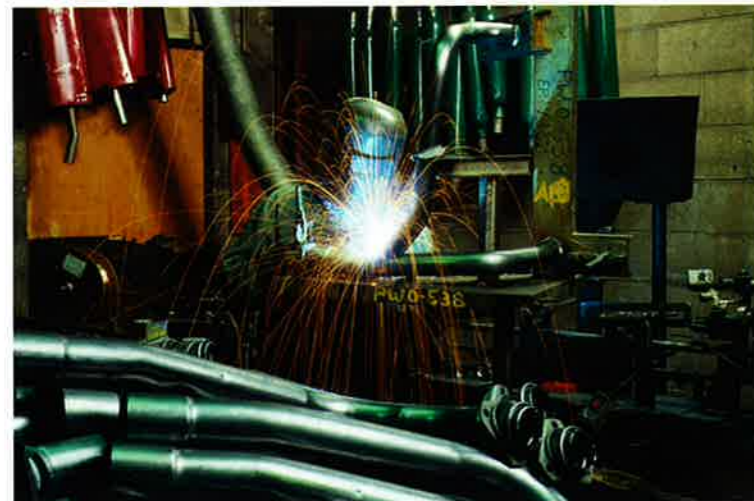
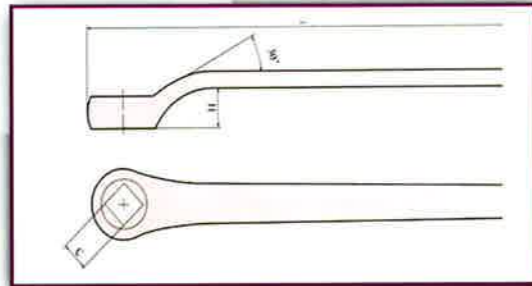

C mm	L mm	H mm	Qualité	Réf
6	110	9	Be-Cu Al-Br	078706 083106
8	120	10	Be-Cu Al-Br	078708 083108
9	140	11	Be-Cu Al-Br	078709 083109
10	140	12	Be-Cu Al-Br	078710 083110
11	160	13	Be-Cu Al-Br	078711 083111
12	190	14	Be-Cu Al-Br	078712 083112
13	200	15	Be-Cu Al-Br	078713 083113
14	250	16	Be-Cu Al-Br	078714 083114
16	250	18	Be-Cu Al-Br	078716 083116
17	300	19	Be-Cu Al-Br	078717 083117
19	350	20	Be-Cu Al-Br	078719 083119
22	400	22	Be-Cu Al-Br	078722 083122
24	500	24	Be-Cu Al-Br	078724 083124

CLE A FOURCHE A BROCHE

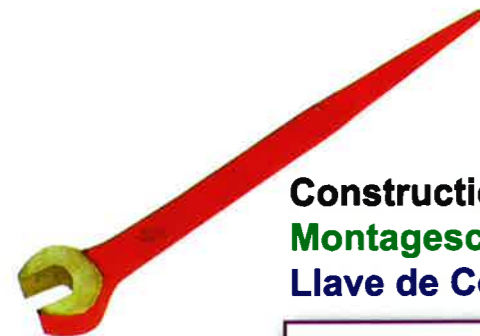

Construction wrench with pin
Montageschlüssel mit Dorn
Llave de Construcción con Perno

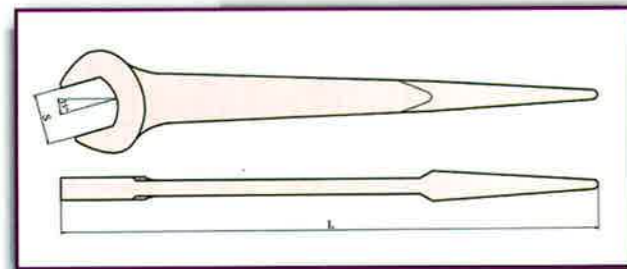

S mm	L mm	Qualité	Réf
19	240	Be-Cu Al-Br	005319 020119
22	280	Be-Cu Al-Br	005322 020122
24	280	Be-Cu Al-Br	005324 020124
27	300	Be-Cu Al-Br	005327 020127
30	320	Be-Cu Al-Br	005330 020130
32	340	Be-Cu Al-Br	005332 020132
36	380	Be-Cu Al-Br	005336 020136

CLE POLYGONALE, COUDEE

S mm	L mm	Qualité	Réf
8	140	Be-Cu Al-Br	005008 019808
10	150	Be-Cu Al-Br	005010 019810
11	160	Be-Cu Al-Br	005011 019811
12	170	Be-Cu Al-Br	005012 019812
13	180	Be-Cu Al-Br	005013 019813
14	190	Be-Cu Al-Br	005014 019814
15	200	Be-Cu Al-Br	005015 019815
16	210	Be-Cu Al-Br	005016 019816
17	220	Be-Cu Al-Br	005017 019817
18	230	Be-Cu Al-Br	005018 019818
19	240	Be-Cu Al-Br	005019 019819
20	250	Be-Cu Al-Br	005020 019820
21	260	Be-Cu Al-Br	005021 019821
22	270	Be-Cu Al-Br	005022 019822
23	280	Be-Cu Al-Br	005023 019823
24	290	Be-Cu Al-Br	005024 019824
25	300	Be-Cu Al-Br	005025 019825
26	310	Be-Cu Al-Br	005026 019826
27	320	Be-Cu Al-Br	005027 019827
28	330	Be-Cu Al-Br	005028 019828
29	340	Be-Cu Al-Br	005029 019829
30	350	Be-Cu Al-Br	005030 019830
32	370	Be-Cu Al-Br	005032 019832

S mm	L mm	Qualité	Réf
34	380	Be-Cu Al-Br	005034 019834
35	385	Be-Cu Al-Br	005035 019835
36	390	Be-Cu Al-Br	005036 019836
38	400	Be-Cu Al-Br	005038 019838
41	410	Be-Cu Al-Br	005041 019841
46	420	Be-Cu Al-Br	005046 019846
50	430	Be-Cu Al-Br	005050 019850
55	440	Be-Cu Al-Br	005055 019855
60	460	Be-Cu Al-Br	005060 019860
65	480	Be-Cu Al-Br	005065 019865
70	500	Be-Cu Al-Br	005070 019870



Construction box wrench offset
Montageringschlüssel gekröpft
Llave de Construcción,
Acodada con Perno

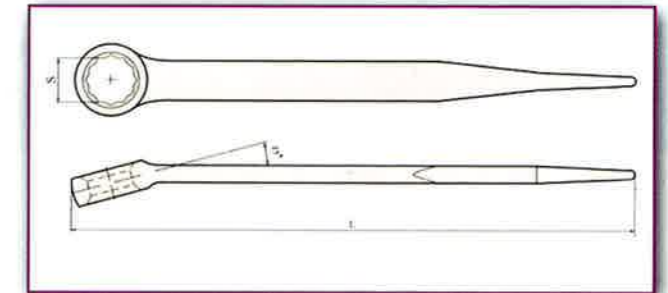

CLE SERRE-TUBE



Adjustable pipe wrench
Verstellbarer Rohrschlüssel
Llave Adjustable para Tubos

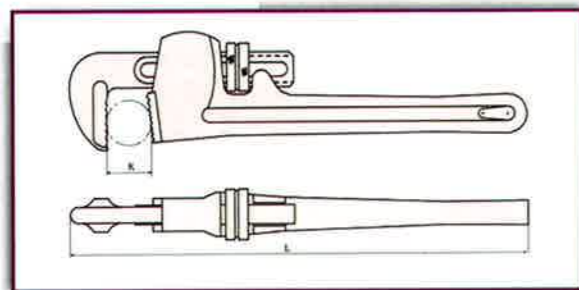

L Inch	L mm	K mm	K Inch	Qualité	Réf
8"	200	25	1"	Be-Cu Al-Br	009502 023702
10"	250	30	1 1/4"	Be-Cu Al-Br	009508 023708
12"	300	40	1 1/2"	Be-Cu Al-Br	009509 023709
14"	350	50	2"	Be-Cu Al-Br	009510 023710
18"	450	60	2 1/2"	Be-Cu Al-Br	009511 023711
24"	600	75	3"	Be-Cu Al-Br	009517 023717
36"	900	125	5"	Be-Cu Al-Br	009520 023720

CLE A SANGLE



Wrench, Belt Pipe
Kettenrohrlicht-schlüssel
Llave, luz de cadena de la pipa

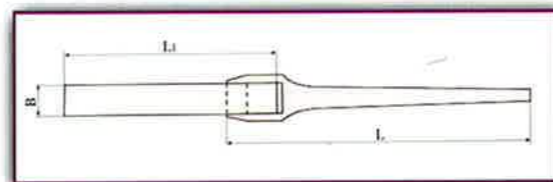

L mm	L1 mm	B mm	Qualité	Réf
300	425	30	Be-Cu Al-Br	078802 083202

CLE SERRE-TUBE A CHAINE (light)



Chain pipe wrench
Kettenrohrzange
Llave Encadenadora de Tubos

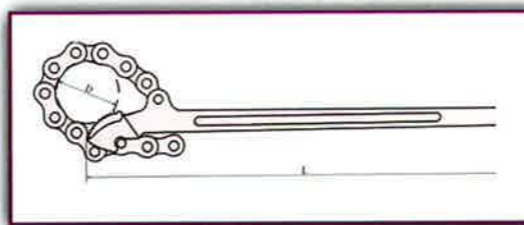

L mm	D mm	K Inch	Qualité	Réf
600	100	4"	Be-Cu Al-Br	009920 024120

COUPE TUBE



Pipe cutter
Rohrabschneider
Cortadora

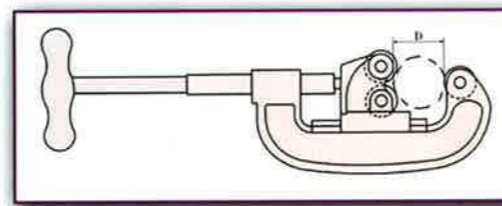

D inch	D mm	Qualité	Réf
2	50	Be-Cu	015102

CLE ANGLAISE



Monkey (Railroad) wrench
Verstellbarer Schraubenschlüssel
Llave Inglesa (Ferrocarril)

K max mm	L mm	Qualité	Réf
48	254	Be-Cu Al-Br	009625 023825
58	305	Be-Cu Al-Br	009630 023830
65	350	Be-Cu Al-Br	009635 023835
70	380	Be-Cu Al-Br	009638 023838

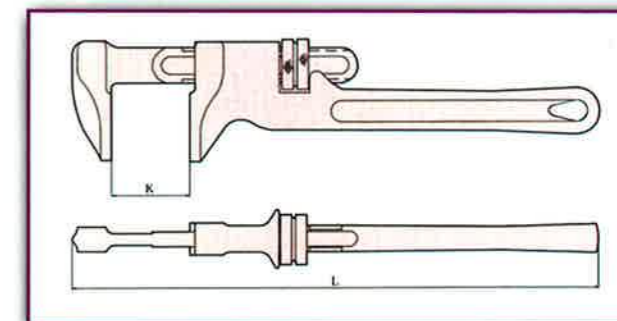

CLE SERRE-TUBE - TYPE SUEDOIS



Pliers, Swedish
Eckrohrzange
Pinza Sueca

L mm	K mm	Qualité	Réf
420	38	Be-Cu Al-Br	077503 024003
530	50	Be-Cu Al-Br	077505 024005

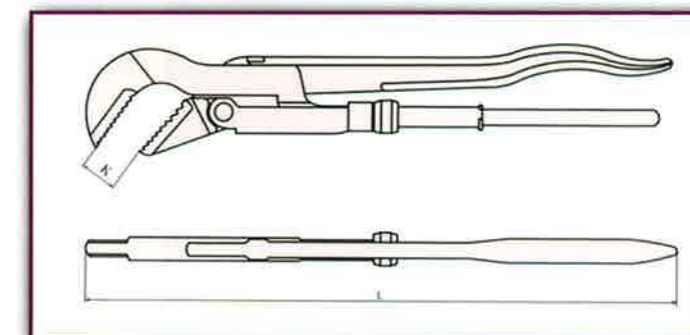

SERRE-TUBE A CHAINE



Chain pipe wrench
Kettenrohrzange
Llave Encadenadora de Tubos

L mm	K mm	D "	Qualité	Réf
600	50	2"	Be-Cu Al-Br	009905 024105
600	100	4"	Be-Cu Al-Br	009907 024107
600	150	6"	Be-Cu Al-Br	009909 024109
900	200	8"	Be-Cu Al-Br	009910 024110
900	300	12"	Be-Cu Al-Br	009911 024111

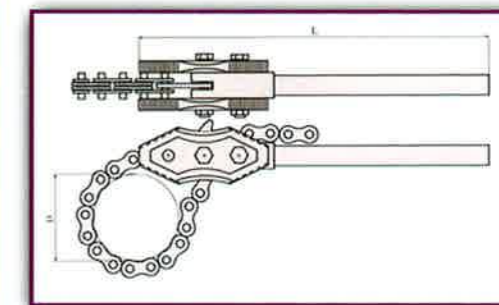

CLE A FRAPPER A FOURCHE



Striking open end wrench
Maulschlüssel, DIN 133
Llave de Boca de Golpe

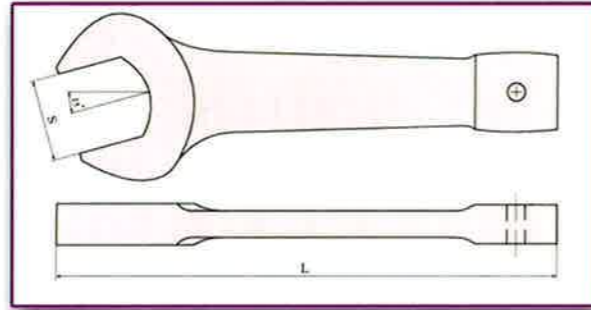

S mm	L mm	Qualité	Réf
17	130	Be-Cu Al-Br	003617 018417
18	135	Be-Cu Al-Br	003618 018418
19	140	Be-Cu Al-Br	003619 018419
22	155	Be-Cu Al-Br	003622 018422
24	165	Be-Cu Al-Br	003624 018424
26	172	Be-Cu Al-Br	003626 018426
27	175	Be-Cu Al-Br	003627 018427
28	178	Be-Cu Al-Br	003628 018428
29	182	Be-Cu Al-Br	003629 018429
30	185	Be-Cu Al-Br	003630 018430
32	195	Be-Cu Al-Br	003632 018432
36	210	Be-Cu Al-Br	003636 018436
38	216	Be-Cu Al-Br	003638 018438
41	225	Be-Cu Al-Br	003641 018441

S mm	L mm	Qualité	Réf
42	228	Be-Cu Al-Br	003642 018442
45	237	Be-Cu Al-Br	003645 018445
48	240	Be-Cu Al-Br	003646 018446
50	255	Be-Cu Al-Br	003650 018450
52	261	Be-Cu Al-Br	003652 018452
55	270	Be-Cu Al-Br	003655 018455
56	273	Be-Cu Al-Br	003656 018456
60	285	Be-Cu Al-Br	003660 018460
63	297	Be-Cu Al-Br	003663 018463
65	305	Be-Cu Al-Br	003665 018465
70	325	Be-Cu Al-Br	003670 018470
75	345	Be-Cu Al-Br	003675 018475
76	349	Be-Cu Al-Br	003676 018476
80	365	Be-Cu Al-Br	003680 018480
90	385	Be-Cu Al-Br	003690 018490

CLE A FRAPPER A FOURCHE

S inch	L mm	Qualité	Réf
11/16	125	Be-Cu Al-Br	030006 033806
3/4	125	Be-Cu Al-Br	030009 033809
7/8	135	Be-Cu Al-Br	030012 033812
1	165	Be-Cu Al-Br	030015 033815
1.1/16	165	Be-Cu Al-Br	030018 033818
1.1/8	180	Be-Cu Al-Br	030019 033819
1.3/16	180	Be-Cu Al-Br	030020 033820
1.1/4	190	Be-Cu Al-Br	030021 033821
1.3/8	210	Be-Cu Al-Br	030022 033822
1.13/32	210	Be-Cu Al-Br	030024 033824
1.1/2	230	Be-Cu Al-Br	030026 033826
1.5/8	230	Be-Cu Al-Br	030027 033827
1.3/4	240	Be-Cu Al-Br	030029 033829
1.13/16	240	Be-Cu Al-Br	030030 033830
2	255	Be-Cu Al-Br	030033 033833
2.1/16	255	Be-Cu Al-Br	030034 033834
2.3/16	272	Be-Cu Al-Br	030036 033836

S inch	L mm	Qualité	Réf
2.13/64	272	Be-Cu Al-Br	030037 033837
2.5/16	290	Be-Cu Al-Br	030038 033838
2.3/8	290	Be-Cu Al-Br	030039 033839
2.1/2	307	Be-Cu Al-Br	030040 033840
2.9/16	307	Be-Cu Al-Br	030042 033842
2.5/8	307	Be-Cu Al-Br	030043 033843
2.3/4	325	Be-Cu Al-Br	030044 033844
2.15/16	343	Be-Cu Al-Br	030045 033845
3	343	Be-Cu Al-Br	030048 033848
3.1/16	360	Be-Cu Al-Br	030049 033849
3.1/8	360	Be-Cu Al-Br	030051 033851
3.3/8	380	Be-Cu Al-Br	030053 033853
3.9/16	400	Be-Cu Al-Br	030060 033860
3.3/4	400	Be-Cu Al-Br	030062 033862
3.15/16	430	Be-Cu Al-Br	030065 033865
4.1/8	430	Be-Cu Al-Br	030067 033867



Striking open end wrench
Maulschlüssel, DIN 133
Llave de Boca de Golpe

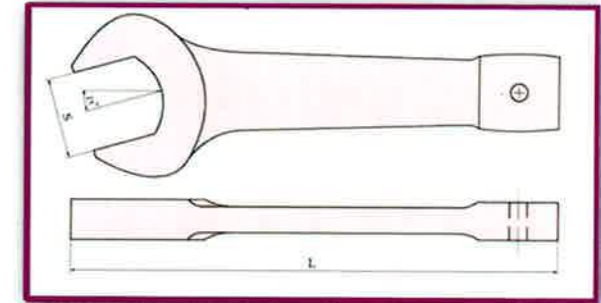

CLE A FRAPPER POLYGONALE, 12 PANS

S mm	L mm	Qualité	Réf	S mm	L mm	Qualité	Réf
17	125	Be-Cu Al-Br	004017 018817	50	250	Be-Cu Al-Br	004050 018850
19	125	Be-Cu Al-Br	004019 018819	52	250	Be-Cu Al-Br	004052 018852
22	125	Be-Cu Al-Br	004022 018822	54	255	Be-Cu Al-Br	004054 018854
24	140	Be-Cu Al-Br	004024 018824	55	265	Be-Cu Al-Br	004055 018855
25	140	Be-Cu Al-Br	004025 018825	56	265	Be-Cu Al-Br	004056 018856
26	140	Be-Cu Al-Br	004026 018826	57	265	Be-Cu Al-Br	004057 018857
27	150	Be-Cu Al-Br	004027 018827	58	280	Be-Cu Al-Br	004058 018858
28	150	Be-Cu Al-Br	004028 018828	60	280	Be-Cu Al-Br	004060 018860
29	165	Be-Cu Al-Br	004029 018829	63	295	Be-Cu Al-Br	004063 018863
30	165	Be-Cu Al-Br	004030 018830	65	295	Be-Cu Al-Br	004065 018865
32	180	Be-Cu Al-Br	004032 018832	67	310	Be-Cu Al-Br	004067 018867
33	180	Be-Cu Al-Br	004033 018833	70	310	Be-Cu Al-Br	004070 018870
34	200	Be-Cu Al-Br	004034 018834	71	310	Be-Cu Al-Br	004071 018871
35	200	Be-Cu Al-Br	004035 018835	75	325	Be-Cu Al-Br	004075 018875
36	200	Be-Cu Al-Br	004036 018836	77	325	Be-Cu Al-Br	004077 018877
37	200	Be-Cu Al-Br	004037 018837	80	340	Be-Cu Al-Br	004080 018880
38	210	Be-Cu Al-Br	004038 018838	82	340	Be-Cu Al-Br	004082 018882
40	210	Be-Cu Al-Br	004040 018840	85	355	Be-Cu Al-Br	004085 018885
41	230	Be-Cu Al-Br	004041 018841	88	390	Be-Cu Al-Br	004088 018888
42	230	Be-Cu Al-Br	004042 018842	90	390	Be-Cu Al-Br	004090 018890
45	230	Be-Cu Al-Br	004045 018845	94	390	Be-Cu Al-Br	004094 018894
46	235	Be-Cu Al-Br	004046 018846	95	390	Be-Cu Al-Br	004095 018895
47	235	Be-Cu Al-Br	004047 018847	100	410	Be-Cu Al-Br	004100 018900



**Striking box wrench
12 point
Ringschlagschlüssel, 12-Kant,
DIN 7444
Llave de Cajon de Golpe,
12 Puntos**

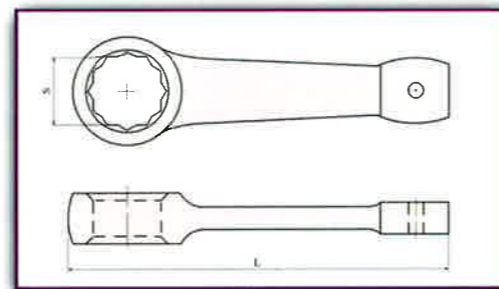

S mm	L mm	Qualité	Réf
105	410	Be-Cu Al-Br	004105 018905
110	450	Be-Cu Al-Br	004110 018910
115	450	Be-Cu Al-Br	004115 018915
120	480	Be-Cu Al-Br	004120 018920
125	480	Be-Cu Al-Br	004125 018925
128	510	Be-Cu Al-Br	004128 018928
130	510	Be-Cu Al-Br	004130 018930
135	510	Be-Cu Al-Br	004135 018935
140	565	Be-Cu Al-Br	004140 018940
145	565	Be-Cu Al-Br	004145 018945
150	565	Be-Cu Al-Br	004150 018950
155	565	Be-Cu Al-Br	004155 018955
160	635	Be-Cu Al-Br	004160 018960



CLE A FRAPPER POLYGONALE, 12 PANS



**Striking box 12 point
Ringschlagschlüssel,
12-kant, DIN 7444
Llave de Cajon de Golpe,
12 Puntos**

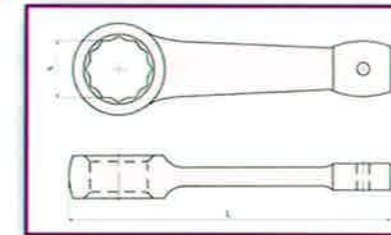

S inch	L mm	Qualité	Réf	S inch	L mm	Qualité	Réf
11/16	108	Be-Cu Al-Br	030203 034003	2-13/64	266	Be-Cu Al-Br	030230 034030
3/4	117	Be-Cu Al-Br	030205 034005	2-5/16	273	Be-Cu Al-Br	030233 034033
7/8	127	Be-Cu Al-Br	030207 034007	2-3/8	275	Be-Cu Al-Br	030236 034036
1	146	Be-Cu Al-Br	030209 034009	2-1/2	282	Be-Cu Al-Br	030239 034039
1-1/16	150	Be-Cu Al-Br	030211 034011	2-9/16	286	Be-Cu Al-Br	030242 034042
1-1/8	159	Be-Cu Al-Br	030212 034012	2-5/8	291	Be-Cu Al-Br	030245 034045
1-3/16	163	Be-Cu Al-Br	030213 034013	2-3/4	298	Be-Cu Al-Br	030248 034048
1-1/4	177	Be-Cu Al-Br	030215 034015	2-15/16	311	Be-Cu Al-Br	030251 034051
1-3/8	200	Be-Cu Al-Br	030216 034016	3	314	Be-Cu Al-Br	030254 034054
1-13/32	208	Be-Cu Al-Br	030218 034018	3-1/16	319	Be-Cu Al-Br	030257 034057
1-1/2	215	Be-Cu Al-Br	030219 034019	3-1/8	325	Be-Cu Al-Br	030260 034060
1-5/8	225	Be-Cu Al-Br	030221 034021	3-3/8	339	Be-Cu Al-Br	030263 034063
1-3/4	236	Be-Cu Al-Br	030222 034022	3-9/16	355	Be-Cu Al-Br	030266 034066
1-13/16	243	Be-Cu Al-Br	030224 034024	3-3/4	370	Be-Cu Al-Br	030269 034069
2	254	Be-Cu Al-Br	030227 034027	3-15/16	387	Be-Cu Al-Br	030272 034072
2-1/16	258	Be-Cu Al-Br	030228 034028	4-1/8	405	Be-Cu Al-Br	030275 034075
2-3/16	264	Be-Cu Al-Br	030229 034029				



CLE A FRAPPER POLYGONALE GROS TRAVAUX



Striking box wrench 12 point - Heavy Duty
Ringschlagschlüssel, 12-Kant, DIN7444-Hocaleistung
Llave de Cajon de Golpe, 12-Puntos-Resistente

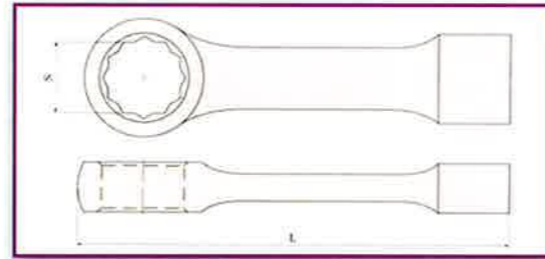

S mm	L mm	Qualité	Réf	S mm	L mm	Qualité	Réf
24	205	Be-Cu Al-Br	004224 019024	60	310	Be-Cu Al-Br	004260 019060
27	205	Be-Cu Al-Br	004227 019027	62	310	Be-Cu Al-Br	004262 019062
30	220	Be-Cu Al-Br	004230 019030	64	320	Be-Cu Al-Br	004264 019064
32	220	Be-Cu Al-Br	004232 019032	65	320	Be-Cu Al-Br	004265 019065
34	220	Be-Cu Al-Br	004234 019034	66	320	Be-Cu Al-Br	004266 019066
36	225	Be-Cu Al-Br	004236 019036	68	330	Be-Cu Al-Br	004268 019068
38	225	Be-Cu Al-Br	004238 019038	70	350	Be-Cu Al-Br	004270 019070
40	250	Be-Cu Al-Br	004240 019040	75	360	Be-Cu Al-Br	004275 019075
41	250	Be-Cu Al-Br	004241 019041	80	370	Be-Cu Al-Br	004280 019080
42	250	Be-Cu Al-Br	004242 019042	85	390	Be-Cu Al-Br	004285 019085
46	265	Be-Cu Al-Br	004246 019046	90	400	Be-Cu Al-Br	004290 019090
48	265	Be-Cu Al-Br	004248 019048	95	415	Be-Cu Al-Br	004295 019095
50	280	Be-Cu Al-Br	004250 019050	98	430	Be-Cu Al-Br	004298 019098
52	280	Be-Cu Al-Br	004252 019052	100	430	Be-Cu Al-Br	004300 019100
55	300	Be-Cu Al-Br	004255 019055	105	430	Be-Cu Al-Br	004305 019105
56	300	Be-Cu Al-Br	004256 019056	110	460	Be-Cu Al-Br	004310 019110
58	300	Be-Cu Al-Br	004258 019058	115	480	Be-Cu Al-Br	004315 019115
				120	480	Be-Cu Al-Br	004320 019120



CLE A FRAPPER POLYGONALE GROS TRAVAUX



Striking box wrench 12 point - Heavy Duty
Ringschlagschlüssel, 12-Kant, DIN7444-Hocaleistung
Llave de Cajon de Golpe, 12-Puntos-Resistente

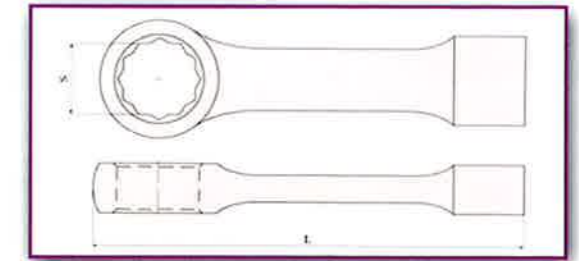

S inch	L mm	Qualité	Réf	S inch	L mm	Qualité	Réf
15/16	205	Be-Cu Al-Br	030303 034103	2-5/8	320	Be-Cu Al-Br	030331 034131
1	205	Be-Cu Al-Br	030304 034104	2-3/4	350	Be-Cu Al-Br	030333 034133
1-1/16	205	Be-Cu Al-Br	030306 034106	2-13/16	350	Be-Cu Al-Br	030334 034134
1-1/4	220	Be-Cu Al-Br	030309 034109	2-15/16	360	Be-Cu Al-Br	030336 034136
1-5/16	220	Be-Cu Al-Br	030310 034110	3-1/8	370	Be-Cu Al-Br	030339 034139
1-7/16	225	Be-Cu Al-Br	030312 034112	3-3/8	390	Be-Cu Al-Br	030342 034142
1-1/2	225	Be-Cu Al-Br	030313 034113	3-1/2	400	Be-Cu Al-Br	030345 034145
1-5/8	250	Be-Cu Al-Br	030315 034115	3-3/4	415	Be-Cu Al-Br	030348 034148
1-11/16	250	Be-Cu Al-Br	030316 034116	3-7/8	430	Be-Cu Al-Br	030351 034151
1-13/16	265	Be-Cu Al-Br	030318 034118	4-1/4	460	Be-Cu Al-Br	030354 034154
1-7/8	265	Be-Cu Al-Br	030319 034119	4-1/2	480	Be-Cu Al-Br	030357 034157
2	280	Be-Cu Al-Br	030321 034121	4-5/8	480	Be-Cu Al-Br	030360 034160
2-1/16	280	Be-Cu Al-Br	030322 034122				
2-3/16	300	Be-Cu Al-Br	030324 034124				
2-1/4	300	Be-Cu Al-Br	030325 034125				
2-3/8	310	Be-Cu Al-Br	030327 034127				
2-7/16	310	Be-Cu Al-Br	030328 034128				
2-9/16	320	Be-Cu Al-Br	030330 034130				



CLE A FRAPPER POLYAGONALE COUDEE

S mm	L mm	Qualité	Réf	S mm	L mm	Qualité	Réf
27	245	Be-Cu Al-Br	004427 019227	70	400	Be-Cu Al-Br	004470 019270
30	270	Be-Cu Al-Br	004430 019230	75	420	Be-Cu Al-Br	004475 019275
32	270	Be-Cu Al-Br	004432 019232	80	435	Be-Cu Al-Br	004480 019280
34	280	Be-Cu Al-Br	004434 019234	85	440	Be-Cu Al-Br	004485 019285
36	280	Be-Cu Al-Br	004436 019236	90	440	Be-Cu Al-Br	004490 019290
41	310	Be-Cu Al-Br	004441 019241	95	440	Be-Cu Al-Br	004495 019295
46	320	Be-Cu Al-Br	004446 019246	100	440	Be-Cu Al-Br	004500 019300
50	320	Be-Cu Al-Br	004450 019250	105	440	Be-Cu Al-Br	004505 019305
55	320	Be-Cu Al-Br	004455 019255	110	440	Be-Cu Al-Br	004510 019310
60	355	Be-Cu Al-Br	004460 019260	115	440	Be-Cu Al-Br	004515 019315
65	380	Be-Cu Al-Br	004465 019265	120	440	Be-Cu Al-Br	004520 019320



**Double hex ring spanner-
offset - flogging**
Ringschlagschlüssel, gekröpft
Llave de cajon de Golpe,
12 puntos

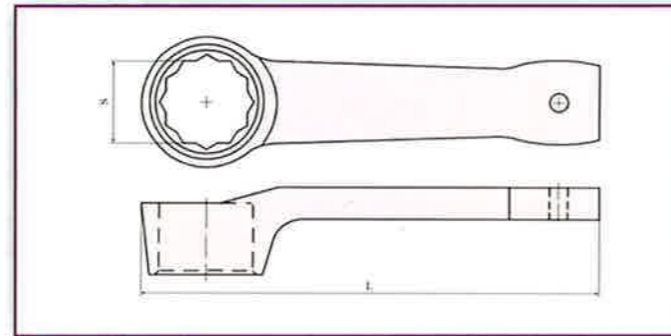

CLE A FRAPPER POLYAGONALE COUDEE

S inch	L mm	Qualité	Réf
1	240	Be-Cu Al-Br	030402 034202
1.1/16	245	Be-Cu Al-Br	030405 034205
1.1/4	270	Be-Cu Al-Br	030408 034208
1.5/16	270	Be-Cu Al-Br	030410 034210
1.7/16	280	Be-Cu Al-Br	030411 034211
1.1/2	290	Be-Cu Al-Br	030413 034213
1.5/8	310	Be-Cu Al-Br	030414 034214
1.11/16	310	Be-Cu Al-Br	030416 034216
1.13/16	320	Be-Cu Al-Br	030417 034217
1.7/8	320	Be-Cu Al-Br	030419 034219
2	320	Be-Cu Al-Br	030420 034220
2.1/16	320	Be-Cu Al-Br	030422 034222
2.3/16	320	Be-Cu Al-Br	030423 034223
2.1/4	320	Be-Cu Al-Br	030425 034225
2.3/8	355	Be-Cu Al-Br	030426 034226
2.7/16	355	Be-Cu Al-Br	030427 034227
2.9/16	380	Be-Cu Al-Br	030429 034229
2.5/8	380	Be-Cu Al-Br	030431 034231
2.3/4	400	Be-Cu Al-Br	030432 034232
2.13/16	400	Be-Cu Al-Br	030434 034234
2.15/16	420	Be-Cu Al-Br	030435 034235
3.1/8	435	Be-Cu Al-Br	030438 034238
3.1/2	440	Be-Cu Al-Br	030444 034244
3.7/8	440	Be-Cu Al-Br	030450 034250



**Double hex ring spanner-
offset - flogging**
Ringschlagschlüssel, gekröpft
Llave de cajon de Golpe,
12 puntos

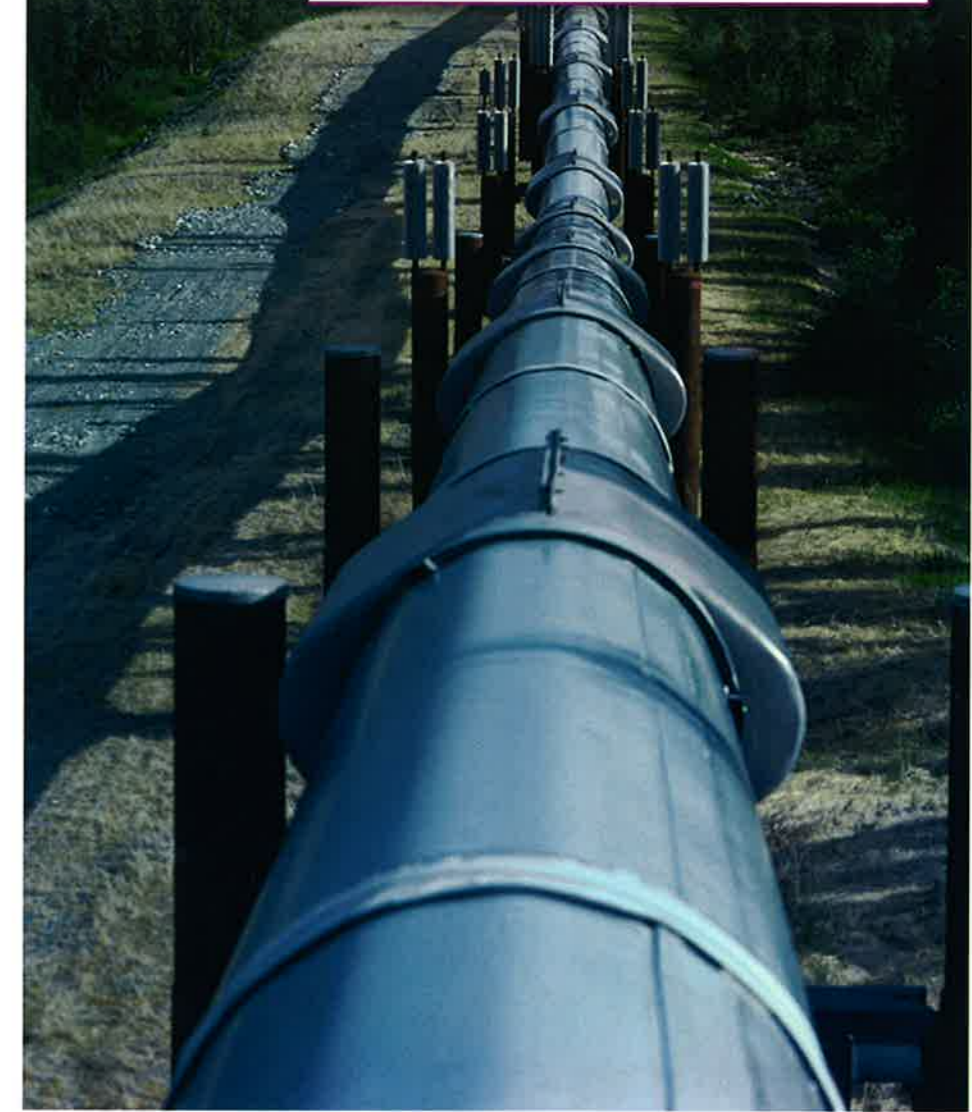
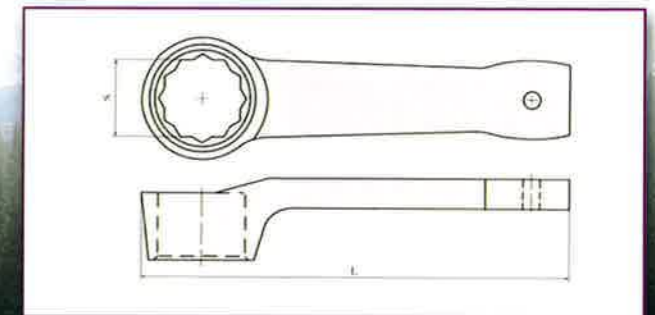

CLE A PIPE 6 PANS

Dim mm	L mm	Qualité	Réf	Dim mm	L mm	Qualité	Réf
8	144	Be-Cu Al-Br	011208 025408	32	310	Be-Cu Al-Br	011232 025432
9	155	Be-Cu Al-Br	011209 025409	33	310	Be-Cu Al-Br	011233 025433
10	168	Be-Cu Al-Br	011210 025410	34	310	Be-Cu Al-Br	011234 025434
11	192	Be-Cu Al-Br	011211 025411	35	310	Be-Cu Al-Br	011235 025435
12	216	Be-Cu Al-Br	011212 025412	36	330	Be-Cu Al-Br	011236 025436
13	240	Be-Cu Al-Br	011213 025413	37	330	Be-Cu Al-Br	011237 025437
14	245	Be-Cu Al-Br	011214 025414	38	330	Be-Cu Al-Br	011238 025438
15	250	Be-Cu Al-Br	011215 025415	41	350	Be-Cu Al-Br	011241 025441
16	255	Be-Cu Al-Br	011216 025416	42	350	Be-Cu Al-Br	011242 025442
17	260	Be-Cu Al-Br	011217 025417	46	360	Be-Cu Al-Br	011246 025446
18	265	Be-Cu Al-Br	011218 025418	47	360	Be-Cu Al-Br	011247 025447
19	270	Be-Cu Al-Br	011219 025419	50	370	Be-Cu Al-Br	011250 025450
20	272	Be-Cu Al-Br	011220 025420	52	370	Be-Cu Al-Br	011252 025452
21	275	Be-Cu Al-Br	011221 025421	54	380	Be-Cu Al-Br	011254 025454
22	278	Be-Cu Al-Br	011222 025422	55	380	Be-Cu Al-Br	011255 025455
23	282	Be-Cu Al-Br	011223 025423	56	380	Be-Cu Al-Br	011256 025456
24	286	Be-Cu Al-Br	011224 025424	58	390	Be-Cu Al-Br	011258 025458
25	286	Be-Cu Al-Br	011225 025425	60	390	Be-Cu Al-Br	011260 025460
26	284	Be-Cu Al-Br	011226 025426	63	400	Be-Cu Al-Br	011263 025463
27	294	Be-Cu Al-Br	011227 025427	65	410	Be-Cu Al-Br	011265 025465
28	294	Be-Cu Al-Br	011228 025428	67	410	Be-Cu Al-Br	011267 025467
29	302	Be-Cu Al-Br	011229 025429	70	420	Be-Cu Al-Br	011270 025470
30	302	Be-Cu Al-Br	011230 025430	71	420	Be-Cu Al-Br	011271 025471
				75	430	Be-Cu Al-Br	011275 025475



**Socket wrench L-type,
6 point
Steckschlüssel, gewinkelt,
6-kant
Llave para Cubo, Tipo-L,
6 puntos**

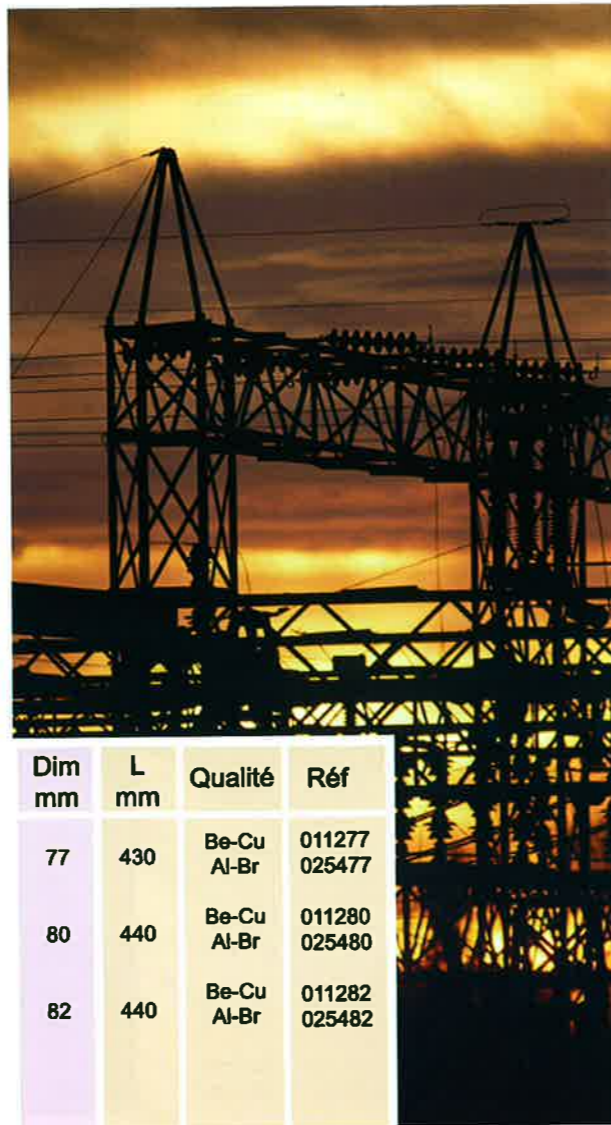
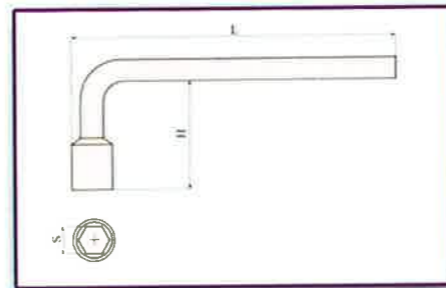

Dim mm	L mm	Qualité	Réf
77	430	Be-Cu Al-Br	011277 025477
80	440	Be-Cu Al-Br	011280 025480
82	440	Be-Cu Al-Br	011282 025482

CLE A PIPE 6 PANS

L inch	L mm	Qualité	Réf	L inch	L mm	Qualité	Réf
5/16	144	Be-cu Al-br	032303 036103	1-9/16	330	Be-cu Al-br	032338 036138
3/8	155	Be-cu Al-br	032305 036105	1-5/8	330	Be-cu Al-Br	032339 036139
13/32	168	Be-cu Al-br	032307 036107	1-11/16	330	Be-cu Al-Br	032340 036140
7/16	192	Be-cu Al-Br	032309 036109	1-3/4	350	Be-cu Al-Br	032341 036141
1/2	216	Be-cu Al-Br	032310 036110	1-13/16	350	Be-cu Al-Br	032342 036142
9/16	245	Be-cu Al-Br	032312 036112	1-7/8	360	Be-cu Al-Br	032343 036143
19/32	250	Be-cu Al-Br	032313 036113	2	360	Be-cu Al-Br	032345 036145
5/8	255	Be-cu Al-Br	032314 036114	2-1/16	370	Be-cu Al-Br	032346 036146
11/16	260	Be-cu Al-Br	032315 036115	2-1/8	370	Be-cu Al-Br	032347 036147
3/4	270	Be-cu Al-Br	032318 036118	2-3/16	380	Be-cu Al-Br	032348 036148
25/32	272	Be-cu Al-Br	032319 036119	2-1/4	380	Be-cu Al-Br	032349 036149
13/16	275	Be-cu Al-Br	032320 036120	2-5/16	380	Be-cu Al-Br	032350 036150
7/8	278	Be-cu Al-Br	032321 036121	2-3/8	390	Be-cu Al-Br	032351 036151
15/16	282	Be-cu Al-Br	032324 036124	2-7/16	390	Be-cu Al-Br	032352 036152
31/32	286	Be-cu Al-Br	032325 036125	2-1/2	400	Be-cu Al-Br	032353 036153
1	286	Be-cu Al-Br	032326 036126	2-9/16	410	Be-cu Al-Br	032354 036154
1-1/16	294	Be-cu Al-Br	032327 036127	2-5/8	410	Be-cu Al-Br	032355 036155
1-1/8	294	Be-cu Al-Br	032330 036130	2-3/4	420	Be-cu Al-Br	032356 036156
1-3/16	302	Be-cu Al-Br	032331 036131	2-13/16	420	Be-cu Al-Br	032357 036157
1-1/4	302	Be-cu Al-Br	032333 036133	2-15/16	430	Be-cu Al-Br	032358 036158
1-5/16	310	Be-cu Al-Br	032334 036134	3	430	Be-cu Al-Br	032359 036159
1-3/8	310	Be-cu Al-Br	032335 036135	3-1/8	440	Be-cu Al-Br	032360 036160
1-7/16	310	Be-cu Al-br	032336 036136	3-1/4	440	Be-cu Al-Br	032361 036161
1-1/2	330	Be-cu Al-br	032337 036137				



**Socket wrench L-type,
6 point
Steckschlüssel, gewinkelt,
6-kant
Llave para Cubo, Tipo-L,
6 puntos**

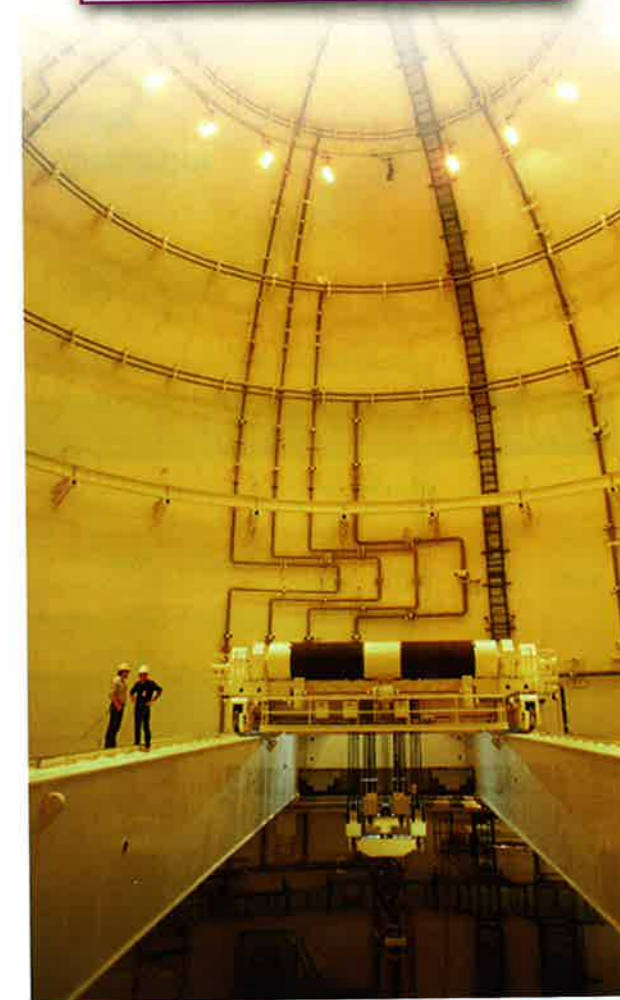
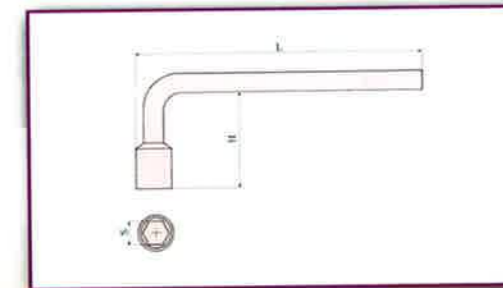

CHASSE GOUPILLE CYLINDRIQUE



Pin punch
Splinttreiber DIN 6450
Botador

Diam mm	L mm	Qualité	Réf	Diam mm	L mm	Qualité	Réf
2	110	Be-Cu Al-Br	006902 021702	12	160	Be-Cu Al-Br	006912 021712
4	110	Be-Cu Al-Br	006904 021704	14	180	Be-Cu Al-Br	006914 021714
6	115	Be-Cu Al-Br	006906 021706	16	200	Be-Cu Al-Br	006916 021716
7	120	Be-Cu Al-Br	006907 021707	18	225	Be-Cu Al-Br	006918 021718
8	120	Be-Cu Al-Br	006908 021708	20	225	Be-Cu Al-Br	006920 021720
10	145	Be-Cu Al-Br	006910 021710				

POINTE A TRACER DOUBLE

L mm	H mm	Ø mm	Qualité	Réf
187	32	4	Be-Cu Al-Br	007101 081201
252	42	4	Be-Cu Al-Br	007103 081203

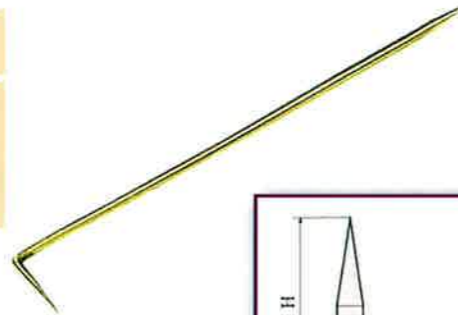

Double-end sciber
Reissnadel
Rayador de Doble Extremo

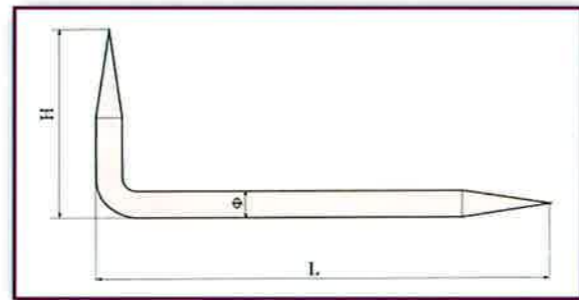

ALENE

L inch	L1 mm	Ø mm	L mm	Qualité	Réf
4	100	3	200	Be-Cu Al-Br	076903 081303



Awl
Vorstecher
Lesna

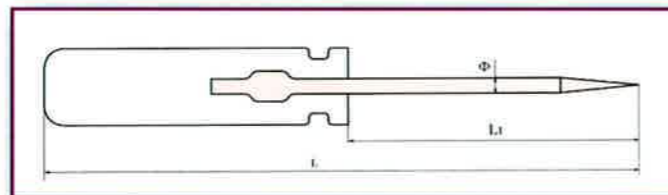

CLE A ERGOT

D mm	L mm	Qualité	Réf
12-14	100	Be-Cu Al-Br	006002 020802
16-20	100	Be-Cu Al-Br	006004 020804
30-32	120	Be-Cu Al-Br	006008 020808
40-42	150	Be-Cu Al-Br	006011 020811
52-55	180	Be-Cu Al-Br	006014 020814
68-75	210	Be-Cu Al-Br	006018 020818
95-100	240	Be-Cu Al-Br	006022 020822

Hook spanner
Hakenschlüssel
Llave de Gancho

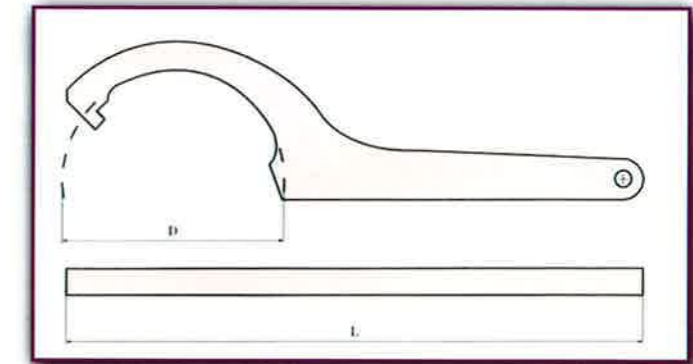

CLE A ERGOT ARTICULEE

Dim mm	L mm	Qualité	Réf
32-75	205	Be-Cu Al-Br	006102 020902

Adjustable hook
Gelenkhakenschlüssel
Llave de Gancho Ajustable

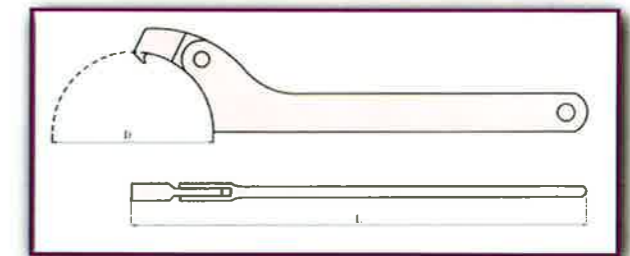

MARTEAU DE MAÇON



Hammer, bricklayer's
Maurerhammer
Martillo de Albanil

H g	L mm	g	Qualité	Réf
600	305	750	Be-Cu Al-Br	002401 017301

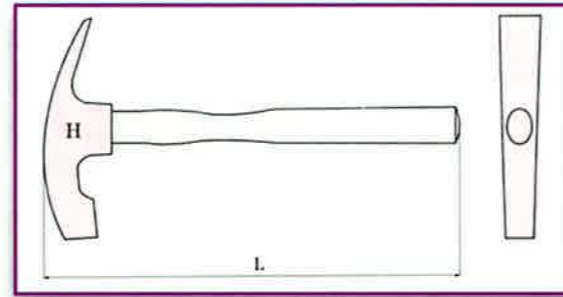

MARTEAU DE CHARPENTIER

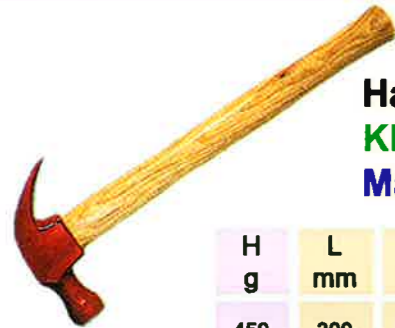

Hammer, claw
Klauenhammer
Martillo con Garra

H g	L mm	g	Qualité	Réf
450	300	652	Be-Cu Al-Br	003501 018301

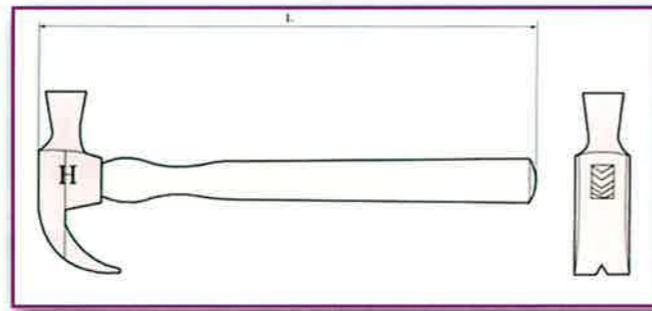

MARTEAU DE MECANICIEN, DIN 1041

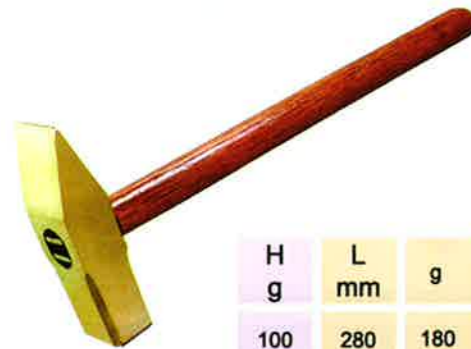

Hammer, cross pein engineer's
Schlosserhammer, DIN 1041
Martillo de Ingeniero de Golpe Cruzado

H g	L mm	g	Qualité	Réf
100	280	180	Be-Cu Al-Br	001301 016201
200	300	300	Be-Cu Al-Br	001302 016202
300	300	425	Be-Cu Al-Br	001303 016203
500	310	655	Be-Cu Al-Br	001304 016204
800	310	955	Be-Cu Al-Br	001305 016205
1000	340	1175	Be-Cu Al-Br	001306 016206
1500	400	1850	Be-Cu Al-Br	001307 016207
2000	450	2455	Be-Cu Al-Br	001308 016208

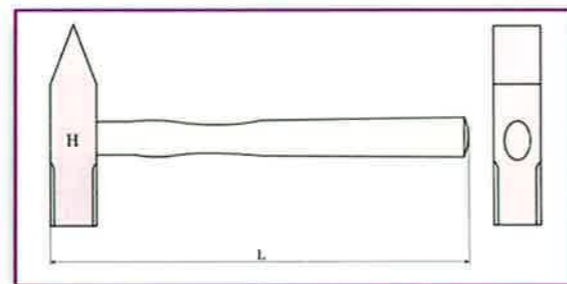

COIN, CASSE JOINT

L mm	B mm	H mm	Qualité	Réf
80	13	6	Be-Cu Al-Br	013016 025816
100	50	10	Be-Cu Al-Br	013004 025804
135	50	18	Be-Cu Al-Br	013006 025806
150	40	8	Be-Cu Al-Br	013012 025812
150	25	8	Be-Cu Al-Br	013008 025808
150	25	13	Be-Cu Al-Br	013010 025810
150	50	13	Be-Cu Al-Br	013014 025814
180	32	13	Be-Cu Al-Br	013018 025818
180	50	19	Be-Cu Al-Br	013020 025820
200	20	30	Be-Cu Al-Br	013022 025822
200	30	30	Be-Cu Al-Br	013024 025824
200	40	40	Be-Cu Al-Br	013026 025826
200	50	12	Be-Cu Al-Br	013028 025828
230	40	20	Be-Cu Al-Br	013030 025830
250	40	30	Be-Cu Al-Br	013032 025832
300	50	40	Be-Cu Al-Br	013034 025834

Wedge, flange
Flanschkeil
Cuna de Pestana

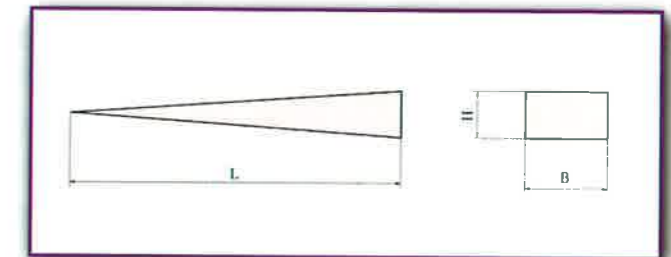
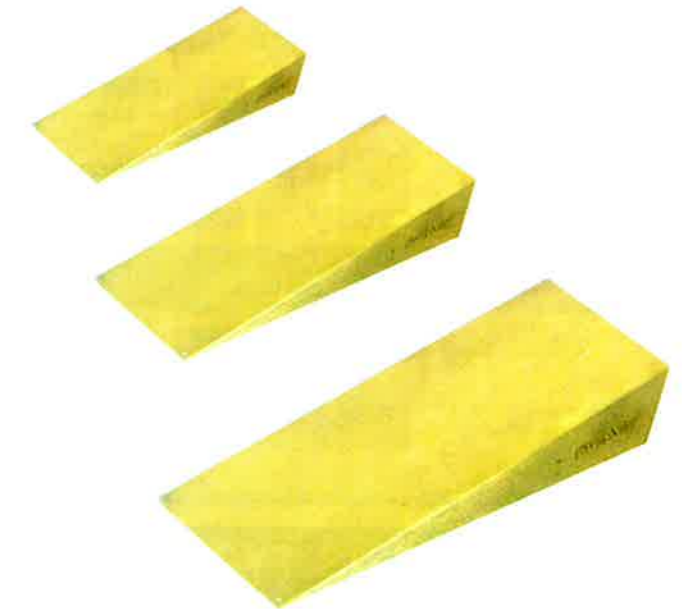

MARTEAU DE MECANICIEN, TYPE AMERICAIN



Hammer, ball pein
Schlosserhammer, amerikanische Form
Martillo de Ingeniero

H g	L mm	g	Qualité	Réf
230	280	403	Be-Cu Al-Br	001107 016007
340	280	502	Be-Cu Al-Br	001108 016008
450	310	680	Be-Cu Al-Br	001109 016009
680	340	950	Be-Cu Al-Br	001110 016010
910	350	1205	Be-Cu Al-Br	001111 016011
1130	400	1470	Be-Cu Al-Br	001112 016012

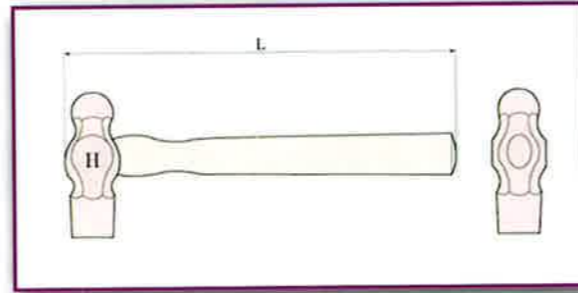

MASSE A PANS TYPE ALLEMAND

H g	L mm	Qualité	Réf
800	400	Be-Cu Al-Br	001500 016400
1000	400	Be-Cu Al-Br	001501 016401
1500	400	Be-Cu Al-Br	001502 016402
2000	450	Be-Cu Al-Br	001503 016403
2500	800	Be-Cu Al-Br	001525 016425
3000	800	Be-Cu Al-Br	001504 016404
4500	900	Be-Cu Al-Br	001545 016445
5000	900	Be-Cu Al-Br	001506 016406
6400	900	Be-Cu Al-Br	001507 016407
8000	900	Be-Cu Al-Br	001508 016408
9900	900	Be-Cu Al-Br	001509 016409

Hammer, sledge, German type
Fäustel, DIN 6475
Acotillo



MARTEAU A PIQUER

H g	L mm	Qualité	Réf
150	330	Be-Cu Al-Br	001701 016601
400	350	Be-Cu Al-Br	001702 016602
700	380	Be-Cu Al-Br	001703 016603
900	400	Be-Cu Al-Br	001704 016604



Hammer, scaling
Entrostungshammer
Martillo Burilador

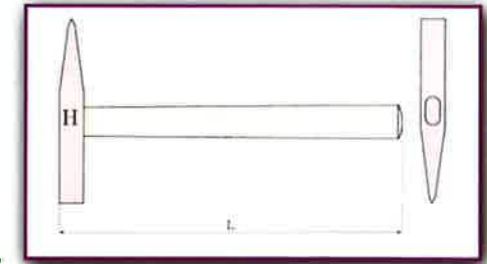

MASSE A PANS

H g	L mm	Qualité	Réf
800	400	Be-Cu Al-Br	001400 016300
1000	400	Be-Cu Al-Br	001401 016301
1500	400	Be-Cu Al-Br	001402 016302
2000	450	Be-Cu Al-Br	001407 016307
2500	800	Be-Cu Al-Br	001403 016303
3000	800	Be-Cu Al-Br	001404 016304
4500	900	Be-Cu Al-Br	001409 016309
5000	900	Be-Cu Al-Br	001405 016305
6400	900	Be-Cu Al-Br	001412 016312
8000	900	Be-Cu Al-Br	001406 016306
9900	900	Be-Cu Al-Br	001410 016310



Hammer, sledge
Fäustel, amerikanische Form
Acotillo

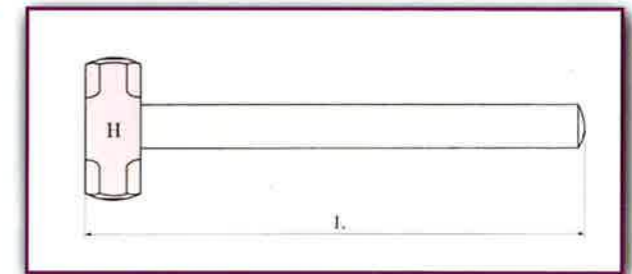

BEDANE

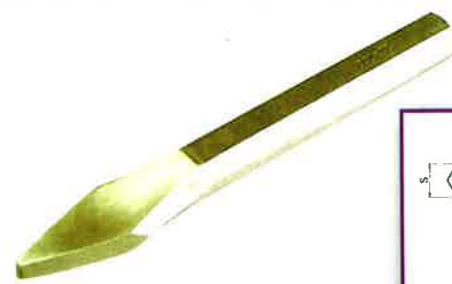

Chisel, groove
Nutenmeißel
Cinzel de Ranura

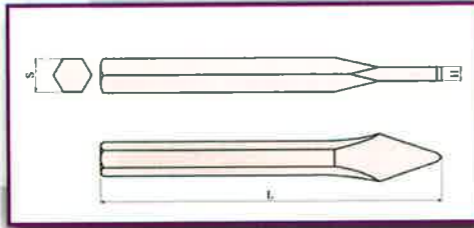

S mm	L mm	H mm	Qualité	Réf
18	150	6	Be-Cu Al-Br	007415 022015
20	200	8	Be-Cu Al-Br	007420 022020
23	300	10	Be-Cu Al-Br	007430 022030

BURIN HEXAGONAL (6 POINTS)



Chisel Hex (6)
Meißel Hex (6)
Cinzel Hex (6)

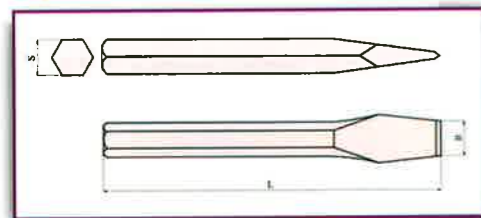

S mm	L mm	B mm	Qualité	Réf	S mm	L mm	B mm	Qualité	Réf
10	150	12	Be-Cu Al-Br	007702 022302	17	350	19	Be-Cu Al-Br	007712 022312
14	200	16	Be-Cu Al-Br	007704 022304	22	600	24	Be-Cu Al-Br	007714 022314
16	160	18	Be-Cu Al-Br	007706 022306	25	300	28	Be-Cu Al-Br	007716 022316
14	250	16	Be-Cu Al-Br	007708 022308	30	500	35	Be-Cu Al-Br	007718 022318
17	300	19	Be-Cu Al-Br	007710 022310					

BURIN POINTE DE DIAMANT



Chisel, diamond point
Diamantspitzmeißel
Cinzel punta de Diamante

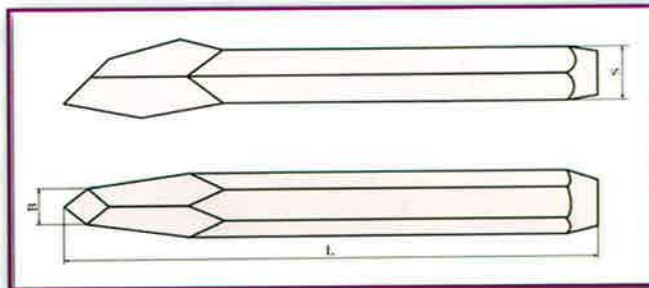

L mm	Qualité	Réf
200	Be-cu Al-br	008020 022520
250	Be-cu Al-br	008025 022525
300	Be-cu Al-br	008030 022530
400	Be-cu Al-br	008040 022540

BURIN PLAT



Chisel Flat
Meißel Flach
Cortafrio

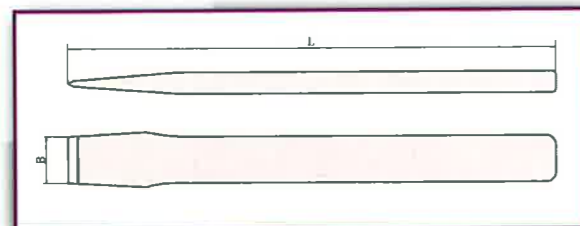

B mm	L mm	Qualité	Réf
22	150	Be-Cu Al-Cu	007310 021910
22	200	Be-Cu Al-Br	007320 021920
24	250	Be-Cu Al-Br	007325 021925
24	300	Be-Cu Al-Br	007330 021930
27	400	Be-Cu Al-Br	007340 021940

MATOIR



Caulking tool, flat edge, offset
Stemmwerkzeug, Kante stumpf, gekröpft
Herramienta de Rematar

L mm	B mm	H mm	Qualité	Réf
200	20	5	Be-Cu Al-Br	008105 022605
250	20	8	Be-Cu Al-Br	008108 022608

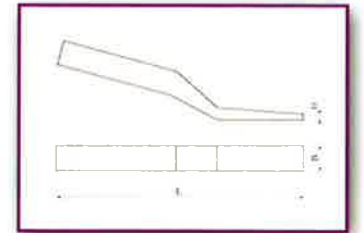

HACHE DE POMPIER



Axe, pick head
Feuerwehraxt
Hacha de Bombero

L mm	H mm	B mm	Qualité	Réf
340	200	98	Be-Cu Al-Br	013201 026001

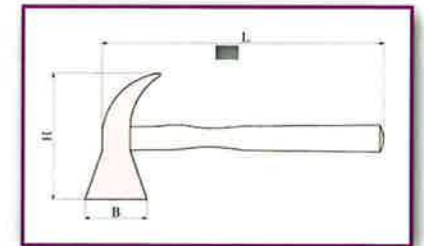

HACHETTE DE CHARPENTIER



Hatchet
Beil
Hachuela

L mm	H mm	B mm	Qualité	Réf
340	145	82	Be-Cu Al-Br	013101 025901

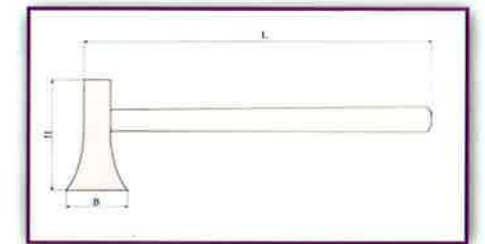

ENCLUME



Anvil
Amboß
Yunque

g	H mm	K mm	Qualité	Réf
3000	63	92	Be-Cu Al-Br	076503 080903
5000	75	111	Be-Cu Al-Br	076505 080905
16000	114	160	Be-Cu Al-Br	076516 080916

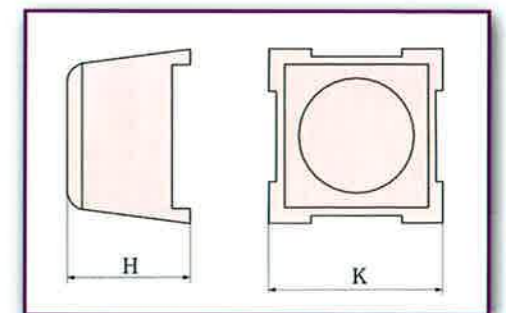

PINCE A DECOFFRER

L mm	Ø mm	B mm	H mm	Qualité	Réf
250	13	15	1,5	Be-Cu Al-Br	029602 026302



Bar, wrecking
Nageleisen mit Klaue
Barra de Demolicion

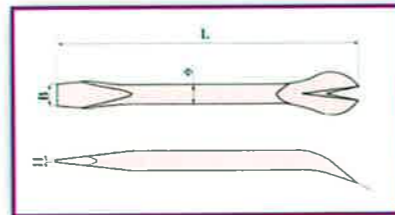

PINCE A DECOFFRER

L mm	Ø mm	Qualité	Réf
400	16	Be-Cu Al-Cu	029620 026320
600	16	Be-Cu Al-Br	029622 026322
800	19	Be-Cu Al-Br	029624 026324
1200	20	Be-Cu Al-Br	029626 026326

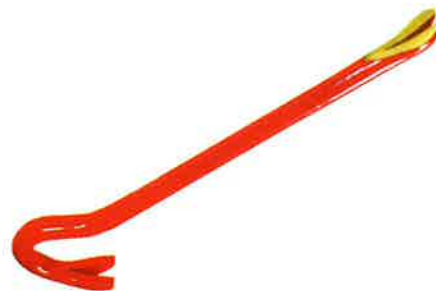

Bar, wrecking
Nageleisen mit Klaue
Barra de Demolicion

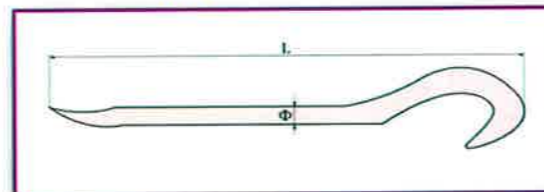

OUVRE-CAISSE

L mm	H mm	Qualité	Réf
230	70	Be-Cu Al-Br	076602 081002



Crate opener
Verschlagöffner
Abre Cajas

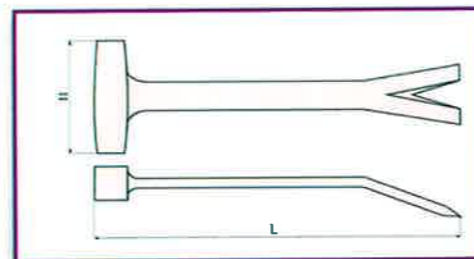

PINCE A TALON

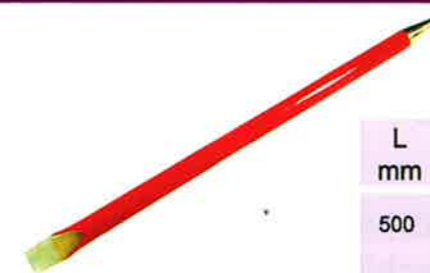

Bar, pinch
Brechstange
Barra Pie de Cabra

L mm	Ø mm	B mm	Qualité	Réf
500	20	20	Be-Cu Al-Br	013308 026108
800	23	23	Be-Cu Al-Br	013311 026111
1000	30	28	Be-Cu Al-Br	013314 026114

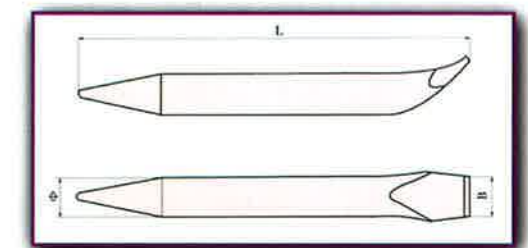

PINCE A TALON



Bar, pinch
Brechstange
Barra Pie de Cabra

L mm	Ø mm	B mm	Qualité	Réf
500	20	20	Be-Cu Al-Br	013332 026132
800	23	23	Be-Cu Al-Br	013337 026137
1000	30	30	Be-Cu Al-Br	013343 026143
1500	30	30	Be-Cu Al-Br	013346 026146

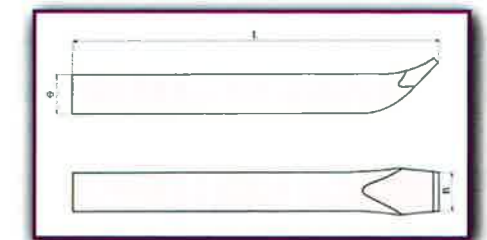

PINCE A TALON



Bar, pinch
Brechstange
Barra Pie de Cabra

L mm	H mm	B mm	Qualité	Réf
600	3	52	Be-Cu Al-Br	013380 026160

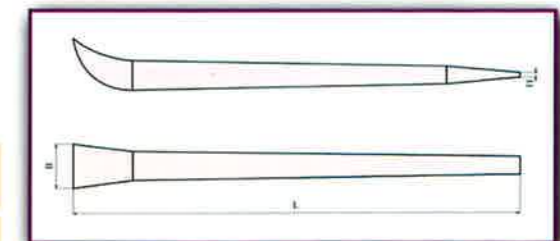

PINCE A LEVIER



Bar, crow
Hebestange
Barra Pata de Gallo

L mm	B mm	Qualité	Réf
1500	30	Be-cu Al-br	076702 028702

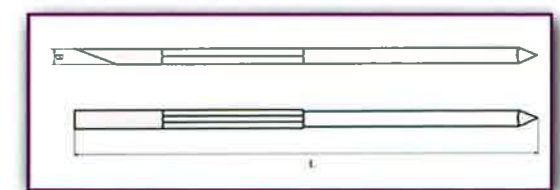

TOURNEVIS PHILLIPS

size	L1 mm	L mm	Qualité	Réf
1	75	153	Be-Cu	011801
2	100	184	Be-Cu	011802
3	150	243	Be-Cu	011803
4	200	305	Be-Cu	011804



Screwdriver, Phillips type
Kreuzschlitz-Schraubendreher
Destornillador Philips

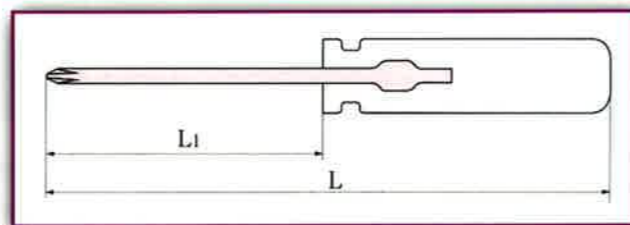

TOURNEVIS POZIDRIV

size	L1 mm	L mm	Qualité	Réf
0	50	108	Be-Cu	079700
1	75	153	Be-Cu	079701
2	100	184	Be-Cu	079702
3	150	243	Be-Cu	079703
4	200	305	Be-Cu	079704



Screwdriver, pozidriv type
Schraubendreher pozidriv
Destornillador pozidriv

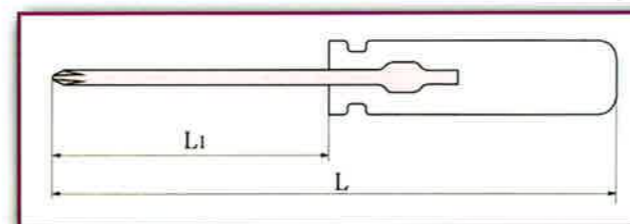

TOURNEVIS LAME PLATE

L mm	L1 mm	B mm	Qualité	Réf
200	100	8	Be-Cu	076402
300	160	10	Be-Cu	076406



Screwdriver
Schraubendreher
Destornillador, Hoja Plana

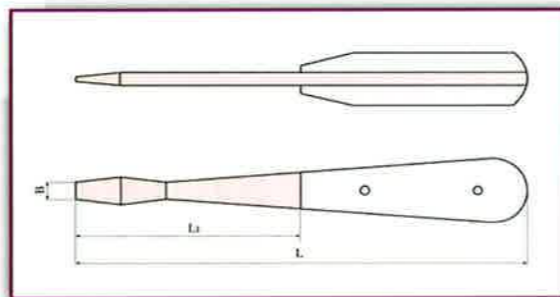

TOURNEVIS COUDE

L mm	H mm	K mm	Qualité	Réf
72	1	6	Be-Cu	011504
125	1.5	8	Be-Cu	011505



Screwdriver, offset
Winkelschraubendreher
Destornillador Acodado

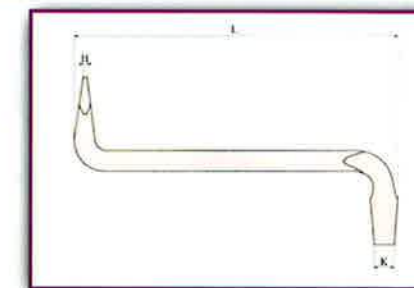

TOURNEVIS, LAME CYLINDRIQUE

L1 mm	L mm	H mm	B mm	Qualité	Réf
50	108	0.5	4	Be-Cu	011405
75	153	0.5	4	Be-Cu	011403
100	184	0.6	5	Be-Cu	011408
150	243	1	7	Be-Cu	011414
200	305	1.2	8	Be-Cu	011417
250	370	2	11	Be-Cu	011420
300	420	2	11	Be-Cu	011423



Screwdriver
Schlitz-Schraubendreher
Destornillador, Hoja Cilindrica

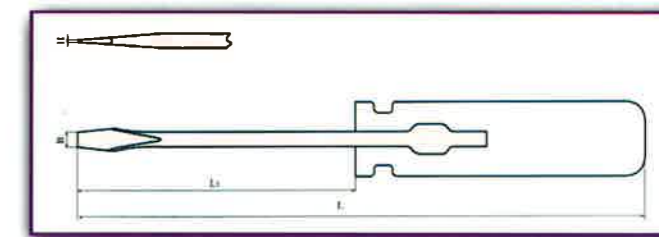

PINCE MULTIPRISE



L inch	L mm	K max mm	Qualité	Réf
10	250	45	Be-Cu Al-Br	010301 024501

Pliers, groove joint
Wasserpumpenzange
 Pinza Junta Estrila

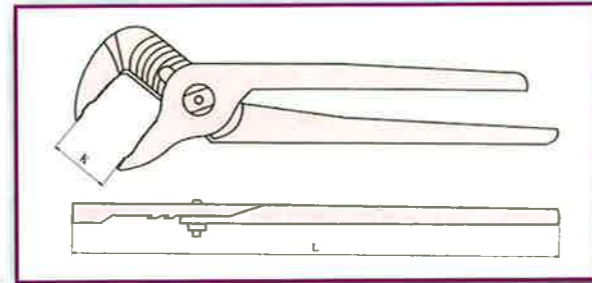

PINCE MULTIPRISE



L inch	L mm	K max mm	Qualité	Réf
10	250	32	Be-Cu Al-Br	010310 024510

Pliers, groove joint
Wasserpumpenzange
 Pinza Junta Estrila

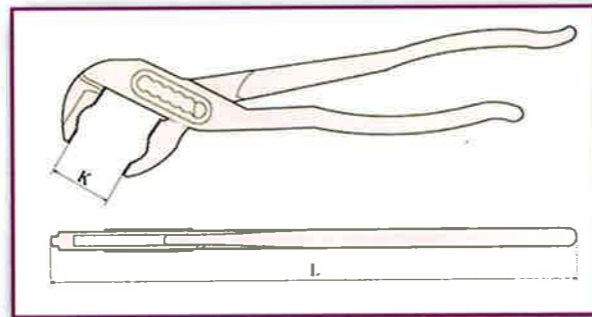

PINCE UNIVERSELLE COUPANTE



L inch	L mm	Qualité	Réf
8	200	Be-cu Al-br	011101 025301

Pliers, combination, with cutter
Kombinationszange, DIN 5244
 Alicate Universal

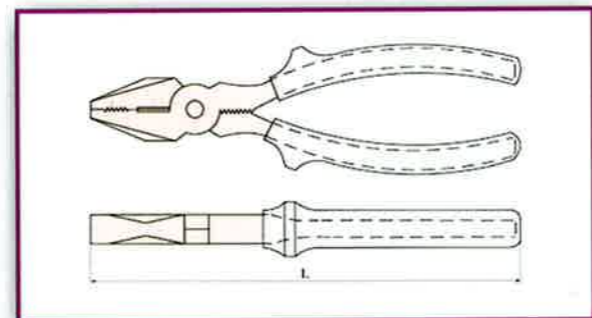

PINCE COMBINEE



L inch	L mm	K mm	Qualité	Réf
8	200	13	Be-cu Al-br	010401 024601

Pliers, adjustable combination
Verstellbare Kombinationszange
 Alicate Ajustable

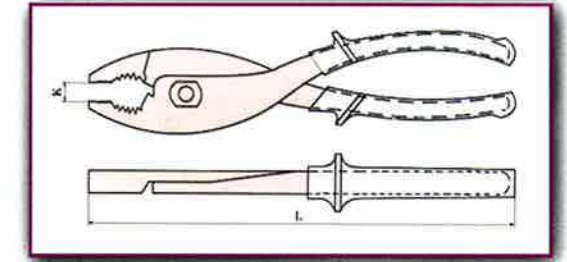

PINCE COUPANTE DIAGONALE



L inch	L mm	Qualité	Réf
6	150	Be-cu Al-br	010001 024201
8	200	Be-cu Al-br	010002 024203

Pliers, diagonal cutting
Seitenschneider, DIN 5238
 Alicate de Corte Diagonal

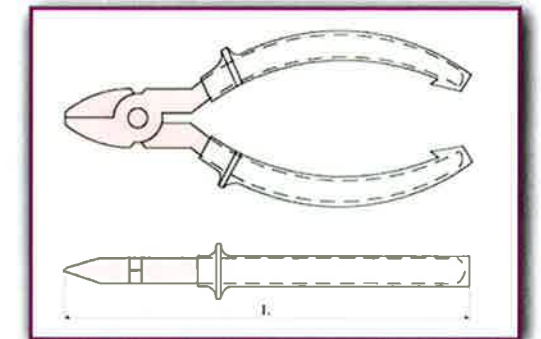

TENAILLE



L inch	L mm	Qualité	Réf
8	180	Be-cu Al-br	010201 024401

Pliers, cutting
BeiBzange, DIN 5241
 Pinza Cortadora

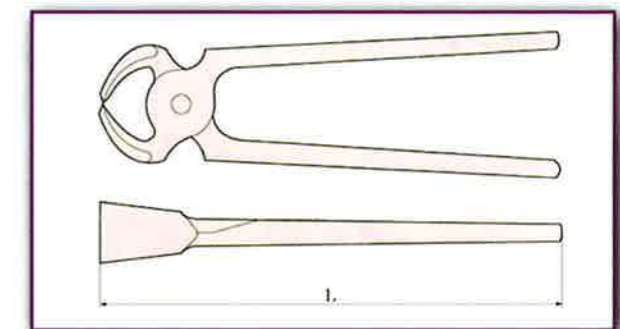

PINCE PLATE



L Inch	L mm	Qualité	Réf
6	150	Be-cu Al-br	010501 024701

Pliers, flat nose
Flachzange, DIN 5248
Alicate de Punta Aplanada

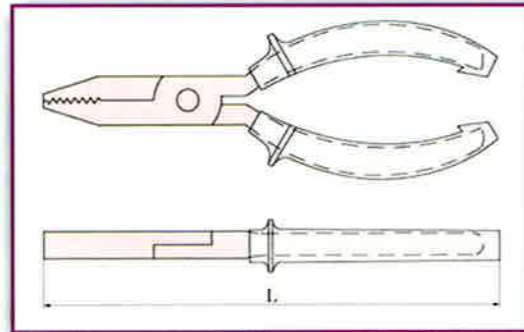

PINCE PLATE A BECS COURTS



L Inch	L mm	K max mm	Qualité	Réf
6	150	54	Be-cu Al-br	036906 037206

Pliers, flat nose
Flachzange, DIN 5248
Alicate de Punta Aplanada

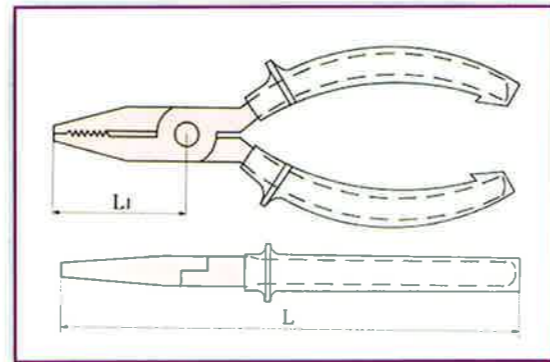

PINCE PLATE A BECS LONGS



L Inch	L mm	L1 mm	Qualité	Réf
8	200	74	Be-cu Al-br	011001 025201

Pliers, long nose, with cutter
Telefonzange
Alicate de Punta Larga con Cortador

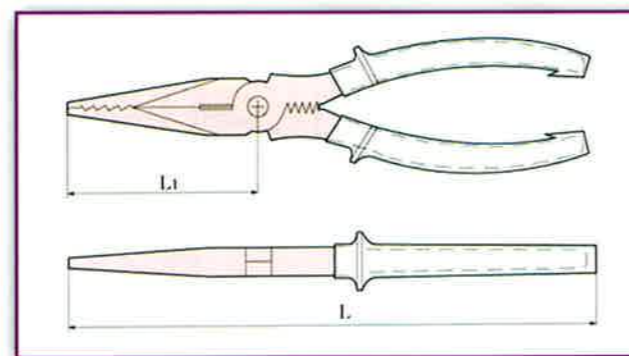

PINCE BECS ROUNDS



L Inch	L mm	Qualité	Réf
6	150	Be-cu Al-br	010801 024801

Pliers, round nose
Rundzange, DIN 5249
Alicate, Bocas Redondas

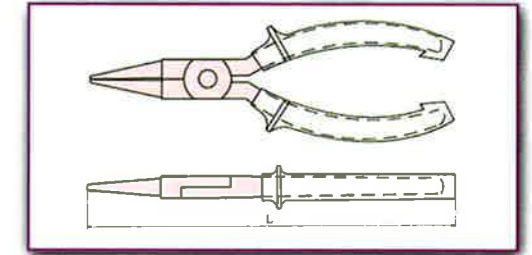

PINCE A SERTIR LES COSSES

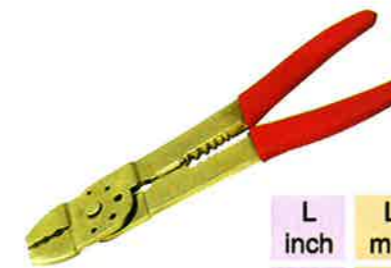

L Inch	L mm	Qualité	Réf
8	200	Be-cu Al-br	078208 082808

Universal crimping pliers
Kombi-PreB und kerbzange
Alicates para terminales

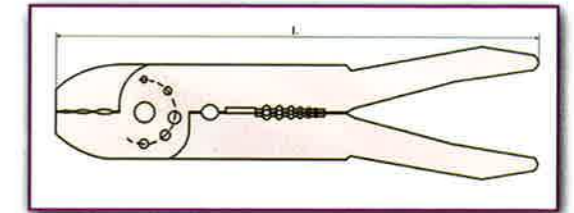

PINCETTE



L mm	Qualité	Réf
200	Be-cu Al-br	010801 025101

Tweezers
Pinzette
Pinzetta

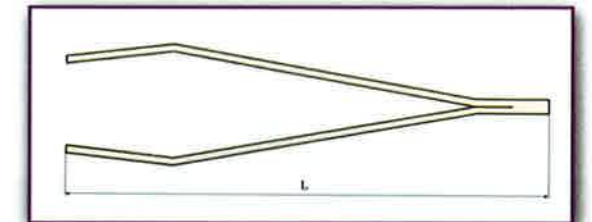

CISEAUX



L Inch	L mm	B mm	Qualité	Réf
9	225	98	Be-Cu	010801

Shears, cutting
Schere
Tijeras

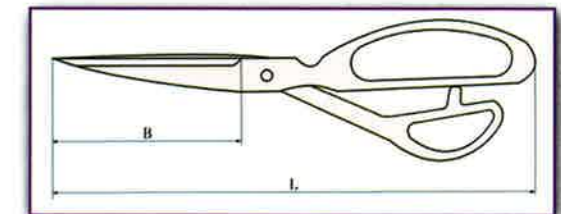

PINCE POUR CIRCLIPS EXTERIEURS



L Inch	L mm	Qualité	Réf
8	200	Be-cu Al-br	038308 038908

Pliers, snap ring, outside
Sicherungsringzange (AuBen), DIN 5254
 Pinza Abre Anillos exteriores

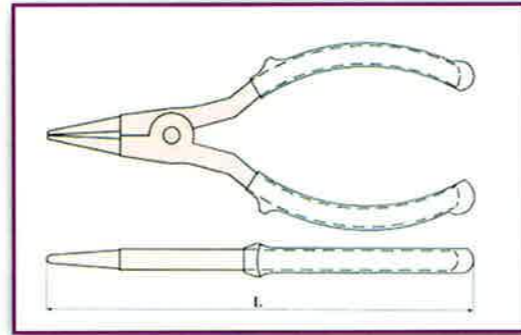

PINCE POUR CIRCLIPS INTERIEURS



L Inch	L mm	Qualité	Réf
8	200	Be-cu Al-br	038208 038808

Pliers, snap ring, inside
Sicherungsringzange (Innen), DIN 5254
 Pinza Abre Anillos Interiors

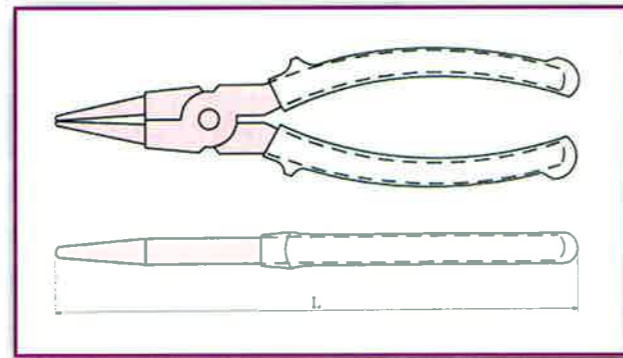

CISAILLE A TÔLE



L mm	Qualité	Réf
275	Be-Cu	010701

Snips, tin
Blechscherere
 Tijeras de Hojalatero



L mm	B mm	Qualité	Réf
300	75	Be-Cu	010703

LIME PLATE



L Inch	L mm	B mm	H mm	Qualité	Réf
10	250	25	6	Be-Cu	076010

Hand file
Flachfeile
 Lima de Mano

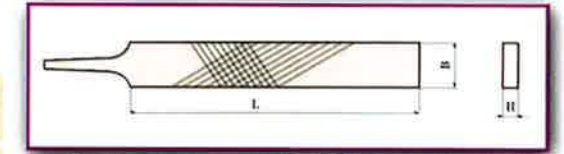

LIME DEMI-RONDE



L Inch	L mm	B mm	H mm	Qualité	Réf
10	250	26	8	Be-Cu	009310

Half round file
Halbrundfeile
 Lima de Media Circunferencia

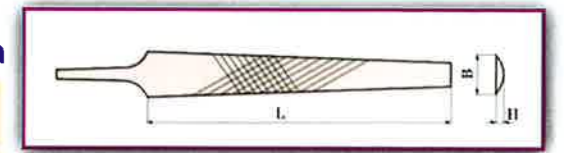

LIME RONDE



L Inch	L mm	Ø mm	Qualité	Réf
10	250	8.5	Be-Cu	076110

Round file
Rundfeile
 Lima Redonda

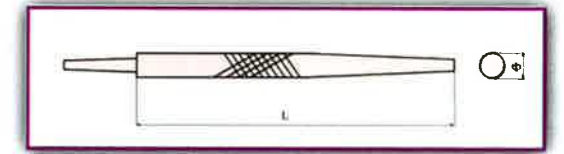

LIME CARREE



L Inch	L mm	B mm	Qualité	Réf
10	250	10	Be-Cu	076210

Square File
Quadrierte feile
 Lima Ajustada

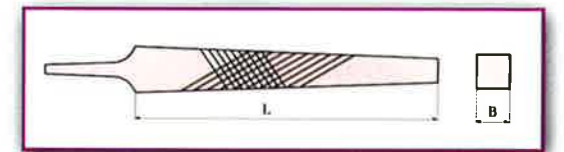

LIME TRIANGULAIRE



L Inch	L mm	B mm	Qualité	Réf
10	250	13	Be-Cu	076310

Triangular File
Dreieckige Feile
 Lima Triangular

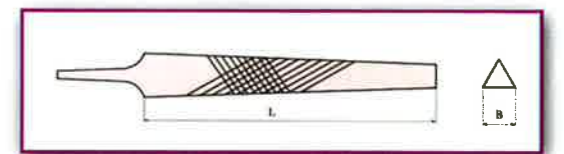

GRATTOIR DE MECANICIEN

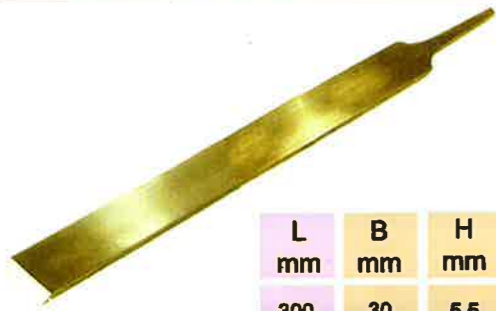

Scraper, flat
Flachschaber
Raspador Plano

L mm	B mm	H mm	Qualité	Réf
300	30	5,5	Be-Cu Al-Br	008230 022730
350	50	6	Be-Cu Al-Br	008235 022735

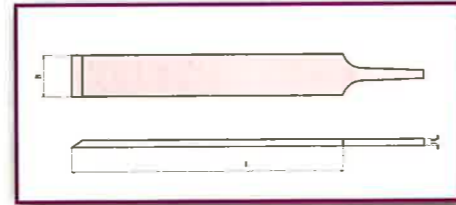

GRATTOIR COUDE

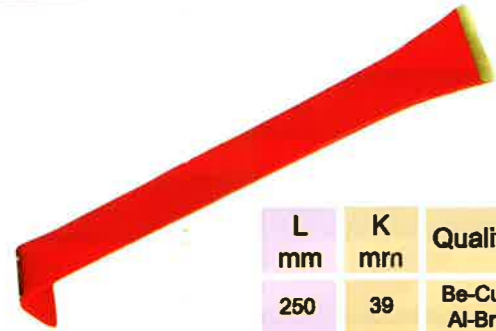

Scraper, deck
Winkelschaber
Raspador Elevado

L mm	K mm	Qualité	Réf
250	39	Be-Cu Al-Br	008300 022900
350	55	Be-Cu Al-Br	008301 022901
400	50	Be-Cu Al-Br	008303 022903

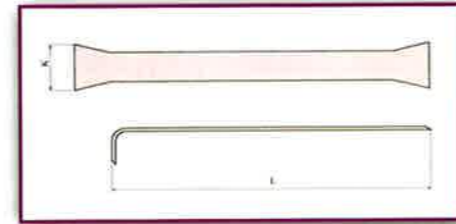

GRATTOIR COUDE

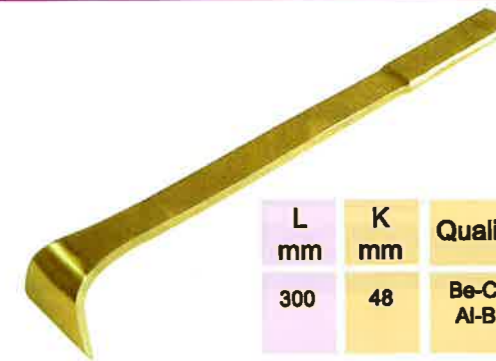

Scraper, deck
Winkelschaber
mit Griff
Raspador Elevado

L mm	K mm	Qualité	Réf
300	48	Be-Cu Al-Br	008330 022930

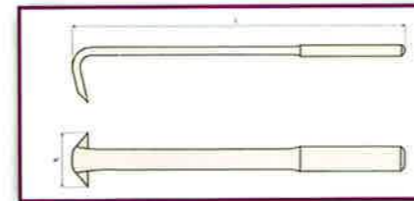

GRATTOIR COUDE

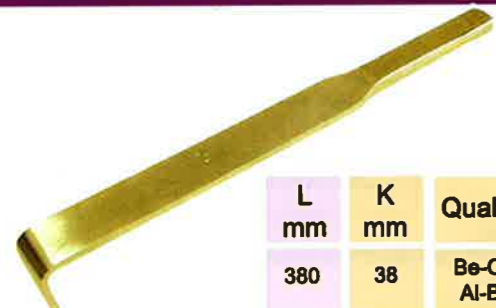

Scraper, deck
Winkelschaber
mit Griff
Raspador Elevado

L mm	K mm	Qualité	Réf
380	38	Be-Cu Al-Br	008338 022938

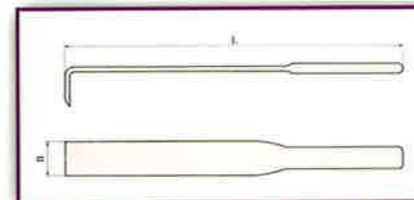

GRATTOIR



Scraper
Schaber
Raspador

L mm	B mm	Qualité	Réf
235	76	Be-Cu Al-Br	077801 082201

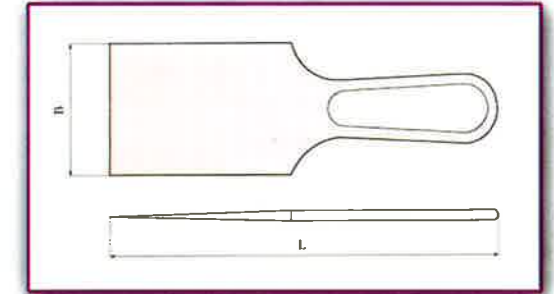

GRATTOIR SANS MANCHE



Scraper, without handle
Schaber, ohne stiel
Raspador, sin mango

B mm	L mm	L ₁ mm	H mm	Qualité	Réf
75	210	117	5.5	Be-Cu Al-Br	008909 023409
100	210	117	6	Be-Cu Al-Br	008910 023410
150	250	150	7	Be-Cu Al-Br	008915 023415

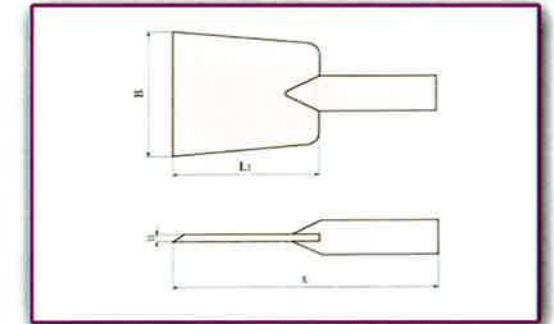

GRATTOIR LAME CONCAVE

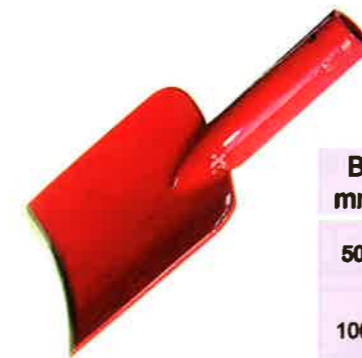

Concave blade tank scraper
Schaber, hohlblatt
Raspador hoja concava

B mm	L mm	L ₁ mm	H mm	Qualité	Réf
50	190	120	10	Be-Cu Al-Br	008929 023429
100	210	120	19	Be-Cu Al-Br	008930 023430
150	220	120	34	Be-Cu Al-Br	008935 023435

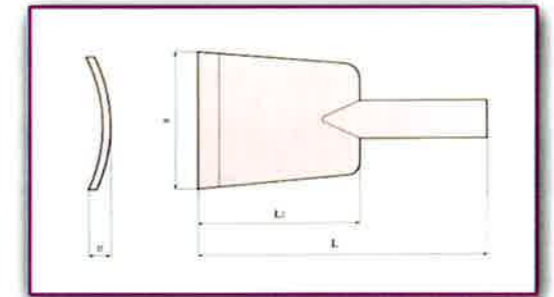

PIC A GRATTOIR



Scraper, pick and scaler
Reinigungswerkzeug
Raspador pico

L mm	B mm	Qualité	Réf
450	75	Be-Cu Al-Br	002801 017501

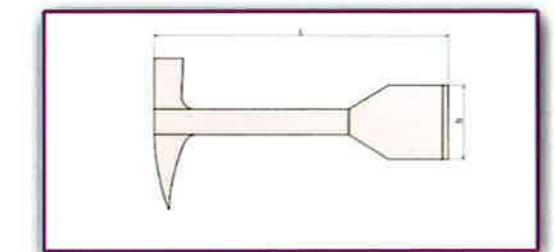

BROSSE A MAIN

L mm	B mm	H mm	Rangs	Qualité	Réf
205	48	41	6*16	Be-cu	012401



Brush, flat back
Kastenbürste, Runddraht glatt
Cepillo de Alambre Redondo

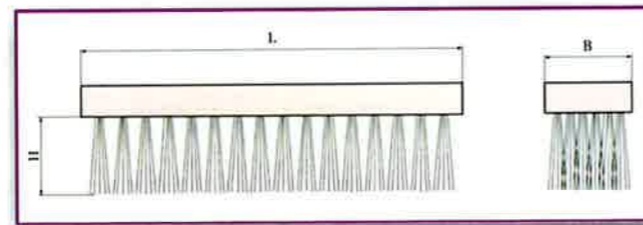

BROSSE A MANCHE

L mm	B mm	H mm	Rangs	Qualité	Réf
290	29	28	4*16	Be-cu	012304



Brush, curved handle
Handdrahtbürste, runddraht glatt
Cepillo de Alambre Redondo

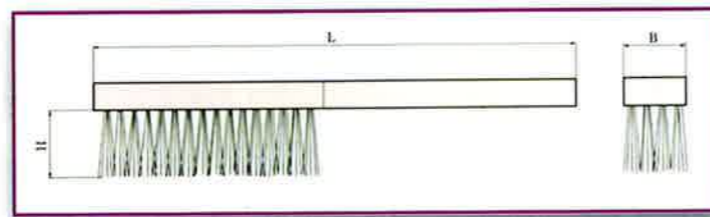

BROSSE POUR BOUGIES

L mm	B mm	H mm	Rangs	Qualité	Réf
215	29	15	6*15	Be-cu	012310



Brush, spark-plug cleaning
Zündkerzenbürste, Runddraht glatt
Cepillo para Bujias

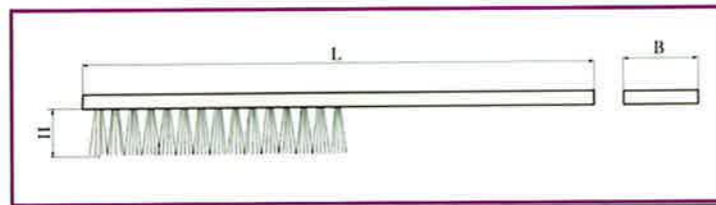

COUTEAU COURBE



Knife, common
Messer
Cuchillo Coün

L mm	L1 mm	Qualité	Réf
150	250	Be-Cu Al-Br	009201 082001

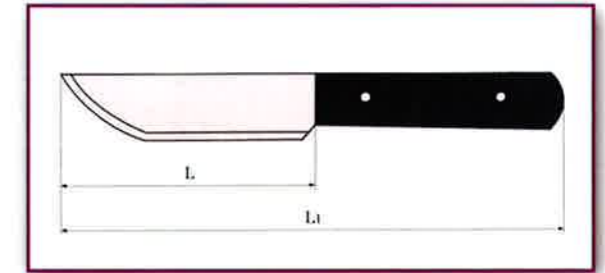

COUTEAU DE VITRIER, LAME RIGIDE



Knife, putty, stiff blade
Spathtel, starres Blatt
Espattuda de Hoja Rigida

K mm	L mm	L1 mm	Qualité	Réf
25	104	200	Be-Cu Al-Br	009008 082108
40	104	200	Be-Cu Al-Br	009009 082109
50	104	200	Be-Cu Al-Br	009010 082110
65	104	200	Be-Cu Al-Br	009012 082112

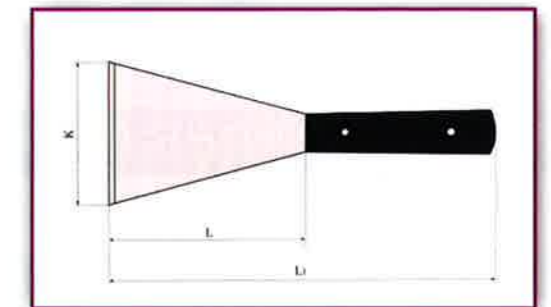

COUTEAU DE VITRIER, LAME RIGIDE

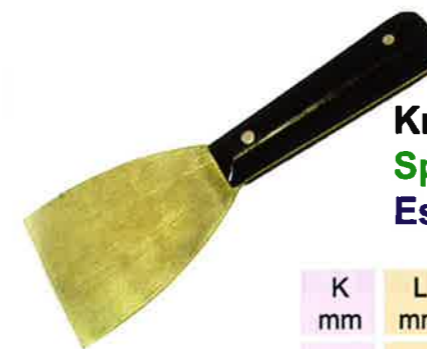

Knife, putty, stiff blade
Spathtel, starres Blatt
Espattuda de Hoja Rigida

K mm	L mm	L1 mm	Qualité	Réf
75	90	200	Be-Cu Al-Br	009028 082128
100	90	200	Be-Cu Al-Br	009030 082130
150	140	250	Be-Cu Al-Br	009032 082132

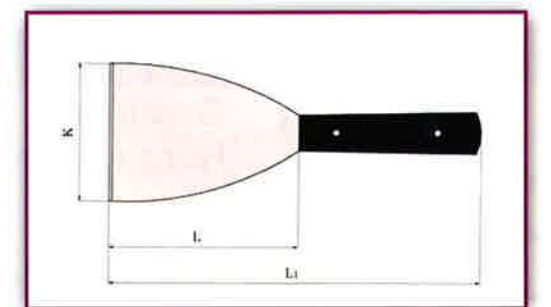

PIOCHE

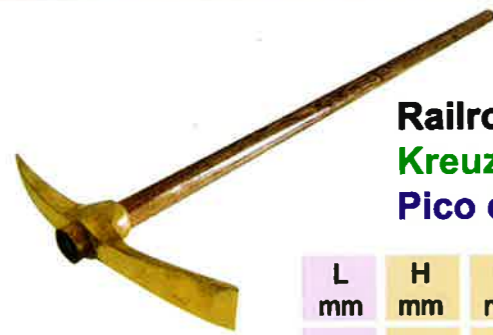

Railroad pick
Kreuzhacke, DIN 20109
Pico de Ferrocarril

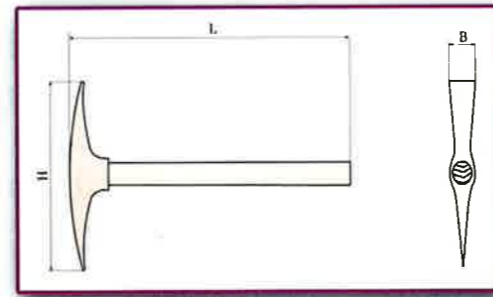

L mm	H mm	B mm	kg	Qualité	Réf
1050	410	56	2,00	Be-Cu Al-Br	001901 016801
1050	470	56	2,40	Be-Cu Al-Br	001903 016803
1050	560	56	3,30	Be-Cu Al-Br	001905 016805
1050	630	58	4,20	Be-Cu Al-Br	001907 016807
1050	750	60	6,00	Be-Cu Al-Br	001909 016809

BECHE, MANCHE A POIGNEE



Edging spade with D-handle
Spaten mit D-Stiel, DIN 20127
Azada de Borde

Dim mm	L mm	Qualité	Réf
190	285	Al-Br	012905

* Avec manche
With handle

RATEAU



Rake
Rechen
Rastrillo

L mm	Qualité	Réf
350	Be-Cu Al-Br	002801 017701

FOURCHE



Fork
Grabgabel
Horquilla de jardin

L mm	B mm	Qualité	Réf
327	200	Be-Cu Al-Br	002001 016901

* Avec manche
With handle

TRUELLE

Trowel, bricklayer's
Maurerkelle
Palustre para Ladrillos

Qualité	Réf
Be-Cu	050000



PELLE CARREE, MANCHE A POIGNEE



Shovel, square edge
Randschaufel, DIN 20123
Pala de Punta Cuadrada

L mm	B mm	H mm	Qualité	Réf
1040	240	418	Be-cu Al-br	077206 081606

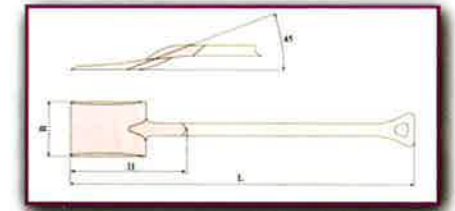

PELLE CREUSE, MANCHE A POIGNEE



Shovel, scoop
Ballastschaufel
Pala Cuchara

L mm	B mm	H mm	Qualité	Réf
1040	270	520	Be-cu Al-br	012705 082705

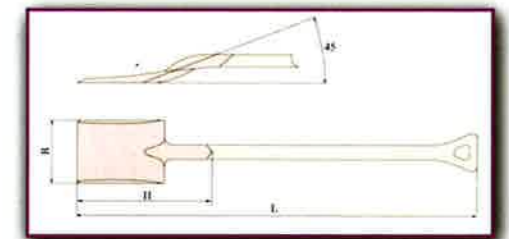

PELLE DE TERRASSIER, MANCHE A POIGNEE



Shovel, round point
Schaufel, Frankfurter
Form, DIN 20121
Pala de Punta Redonda

L mm	B mm	H mm	Qualité	Réf
1000	240	420	Be-cu Al-br	012806 081805

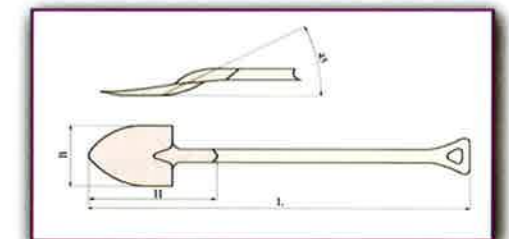

PELLE PLIANTE



Folding Spade
Faltender Spater
Espada que dobla

L mm	B mm	H mm	Qualité	Réf
320	180	130	Be-cu	013502

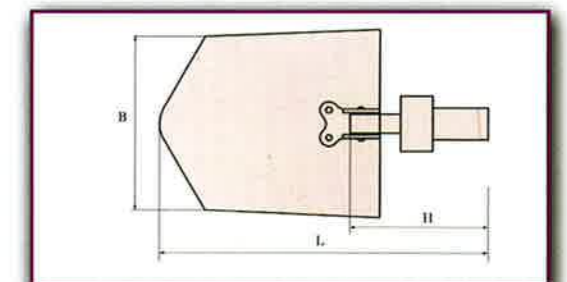

CLE A VALVE

S mm	L mm	H mm	Qualité	Réf
30	200	44	Be-Cu Al-Br	005602 020402
35	250	49	Be-Cu Al-Br	005604 020404
40	300	50	Be-Cu Al-Br	005606 020406
45	350	61	Be-Cu Al-Br	005608 020408
48	375	62	Be-Cu Al-Br	005610 020410
50	400	67	Be-Cu Al-Br	005612 020412
55	450	73	Be-Cu Al-Br	005614 020414
60	500	79	Be-Cu Al-Br	005616 020416
65	550	80	Be-Cu Al-Br	005618 020418
70	600	80	Be-Cu Al-Br	005620 020420
75	650	85	Be-Cu Al-Br	005622 020422
80	700	91	Be-Cu Al-Br	005624 020424
85	750	97	Be-Cu Al-Br	005626 020426
90	800	103	Be-Cu Al-Br	005628 020428
93	850	107	Be-Cu Al-Br	005630 020430
96	900	110	Be-Cu Al-Br	005632 020432
100	1000	114	Be-Cu Al-Br	005634 020434
103	1200	120	Be-Cu Al-Br	005636 020436



Valve wheel hook
Ventilhaken
Gancho Girador de Valvulas

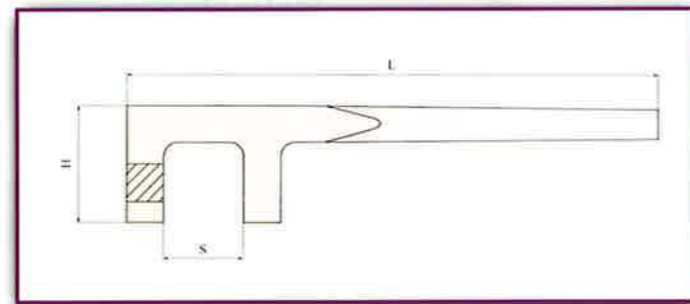

CLE A VALVE

S mm	L mm	H mm	Qualité	Réf
22	200	50	Be-Cu Al-Br	005672 020472
28	250	53	Be-Cu Al-Br	005674 020474
34	300	56	Be-Cu Al-Br	005676 020476
39	350	60	Be-Cu Al-Br	005678 020478
44	400	64	Be-Cu Al-Br	005680 020480
48	450	69	Be-Cu Al-Br	005682 020482
53	500	74	Be-Cu Al-Br	005684 020484
58	550	79	Be-Cu Al-Br	005686 020486
63	600	84	Be-Cu Al-Br	005688 020488



Valve wheel hook
Ventilhaken
Gancho Girador de Valvulas

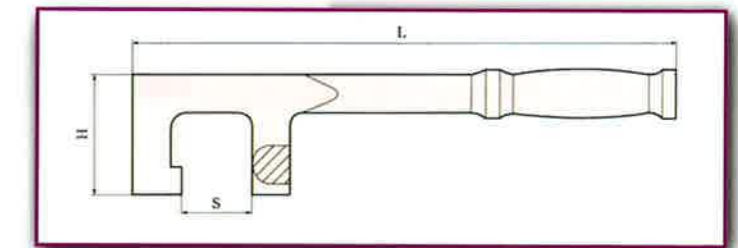

CLE A VALVE

S mm	L mm	H mm	Qualité	Réf
30	200	44	Be-Cu Al-Br	005640 020440
32	300	50	Be-Cu Al-Br	005642 020442
35	250	47	Be-Cu Al-Br	005644 020444
40	300	50	Be-Cu Al-Br	005646 020446
45	350	58	Be-Cu Al-Br	005648 020448
48	375	62	Be-Cu Al-Br	005650 020450
50	400	67	Be-Cu Al-Br	005652 020452
55	450	73	Be-Cu Al-Br	005654 020454
60	500	79	Be-Cu Al-Br	005656 020456
65	550	82	Be-Cu Al-Br	005658 020458
70	600	85	Be-Cu Al-Br	005660 020460



Valve wheel hook
Ventilhaken
Gancho Girador de Valvulas

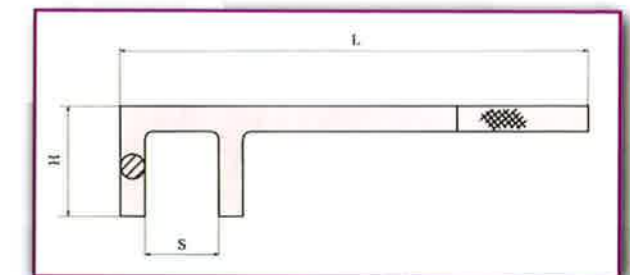

S mm	L mm	H mm	Qualité	Réf
75	650	88	Be-Cu Al-Br	005662 020462
80	700	91	Be-Cu Al-Br	005664 020464
85	750	97	Be-Cu Al-Br	005666 020466
90	800	103	Be-Cu Al-Br	005668 020468

CLE A VOLANT



Wrench,C
Lenkradschlüssel
Clave a volante

L mm	S mm	Qualité	Réf
450	40	Be-Cu Al-Br	079104 083504

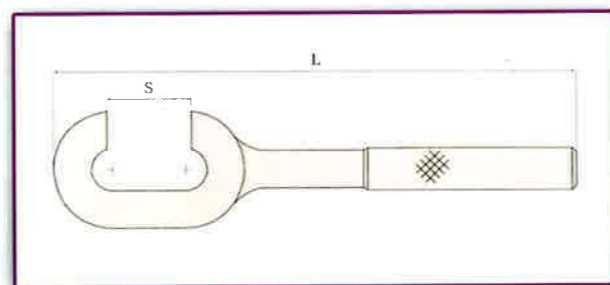

CLE A VOLANT

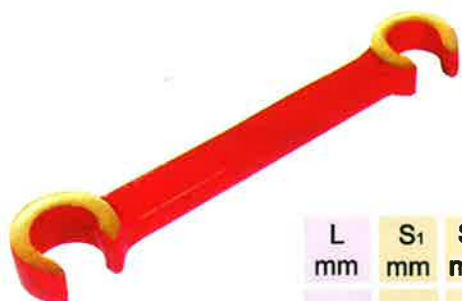

Wrench,C
Lenkradschlüssel
Clave a volante

L mm	S1 mm	S2 mm	Qualité	Réf
200	20	15	Be-Cu Al-Br	079106 083508

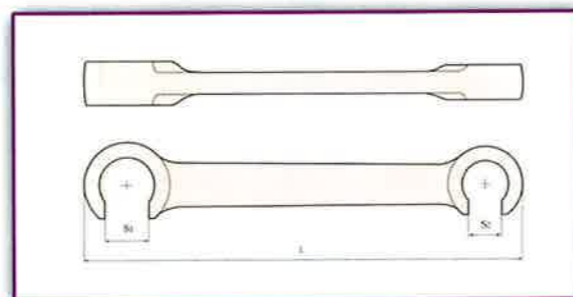

CLE A VOLANT

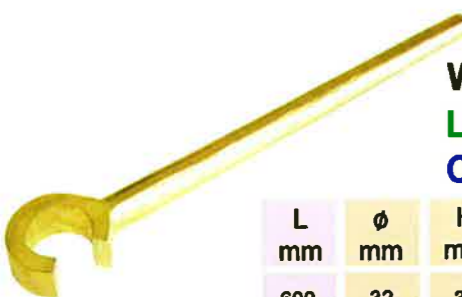

Wrench,C
Lenkradschlüssel
Clave a volante

L mm	φ mm	H mm	Qualité	Réf
600	32	32	Be-cu Al-br	079108 083508

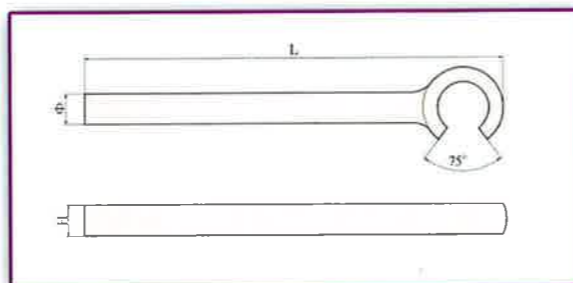

CLE POUR FÛT



Multi-head bung wench
Universalfasschlüssel
Llave taponadora universal

L mm	H mm	Qualité	Réf
300	70	Be-Cu Al-Br	002100 017000

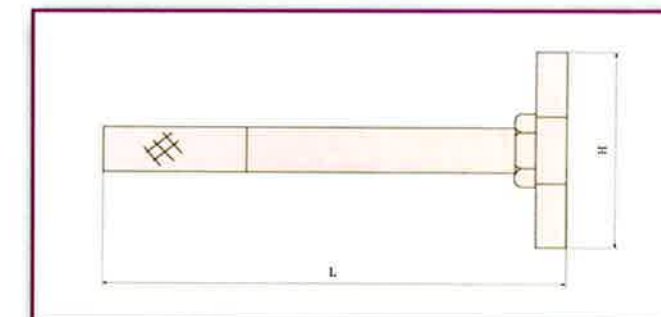

CLE POUR FÛT



Multi-head bung wench
Universalfasschlüssel
Llave taponadora universal

L mm	H1 mm	H2 mm	Qualité	Réf
350	70	95	Be-Cu Al-Br	002101 017001

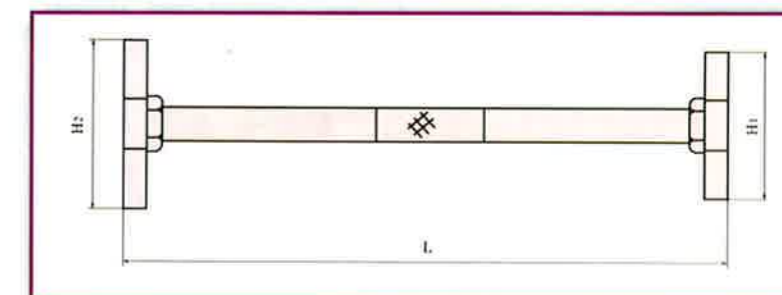

CLE UNIVERSELLE POUR DEBONDER LES FÛTS



Multi-head bung wench
Universalfasschlüssel
Llave taponadora universal

L mm	H1 mm	H2 mm	Qualité	Réf
385	93	61	Be-Cu Al-Br	002201 017101

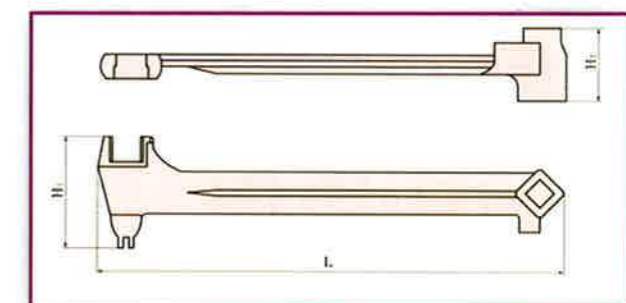

BURIN PNEUMATIQUE



Chisel pneumatic
Pneumatischer meißel
Buril neumatico

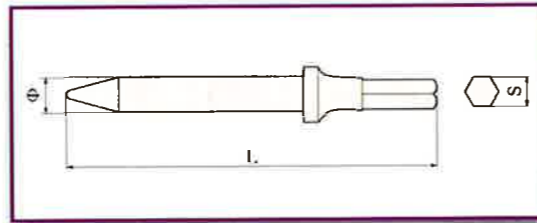

S mm	L mm	Qualité	Réf
10	125	Be-cu Al-br	000302 022202
10	175	Be-cu Al-br	000304 022204

BURIN PNEUMATIQUE



Chisel pneumatic
Pneumatischer meißel
Buril neumatico

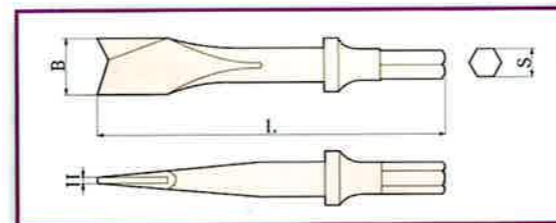

S mm	L mm	B mm	H mm	Qualité	Réf
10	125	20	2	Be-cu Al-br	000310 022210
10	175	20	2	Be-cu Al-br	000312 022212

POINTE DE MAÇON



Point of mason
Mauerspitze
Punta de albanil

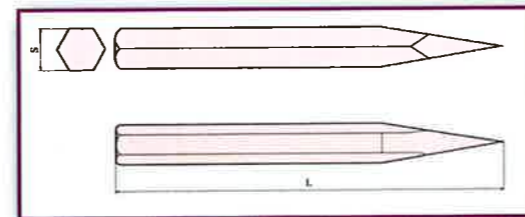

S mm	L mm	Qualité	Réf	S mm	L mm	Qualité	Réf
14	150	Be-cu Al-br	079014 083414	20	250	Be-cu Al-br	079020 083420
18	200	Be-cu Al-br	079018 083418	20	300	Be-cu Al-br	079022 083422

BURIN PNEUMATIQUE



Chisel pneumatic
Pneumatischer meißel
Buril neumatico

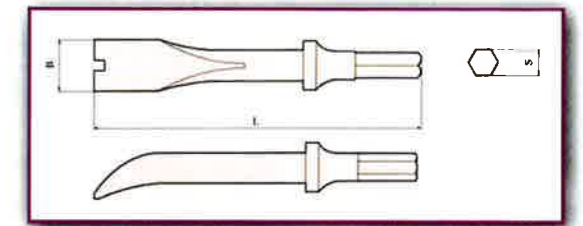

S mm	L mm	B mm	Qualité	Réf
10	125	20	Be-cu Al-br	000330 022230
10	175	20	Be-cu Al-br	000332 022232

BURIN PNEUMATIQUE



Chisel pneumatic
Pneumatischer meißel
Buril neumatico

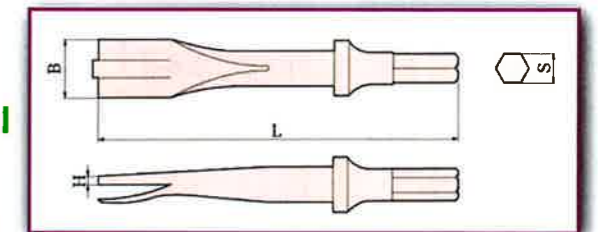

S mm	L mm	H mm	B mm	Qualité	Réf
10	125	2	20	Be-cu Al-br	000336 022236
10	175	2	20	Be-cu Al-br	000338 022238

BURIN PNEUMATIQUE



Chisel pneumatic
Pneumatischer meißel
Buril neumatico

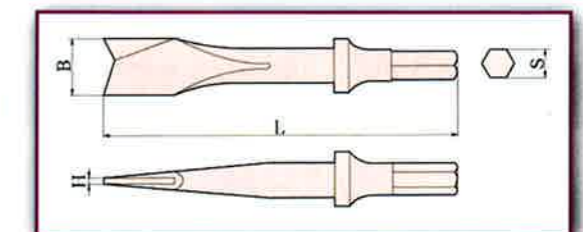

S mm	L mm	H mm	B mm	Qualité	Réf
10	125	2	20	Be-cu Al-br	000342 022242
10	175	2	20	Be-cu Al-br	000344 022244

BURIN PNEUMATIQUE



Chisel pneumatic
Pneumatischer meißel
Buril neumatico

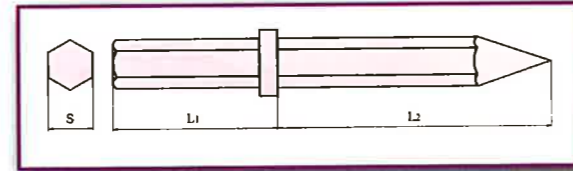

S mm	L1 mm	L2 mm	Qualité	Réf
28	150	350	Be-cu Al-br	000328 022228

GRATTOIR TRIANGULAIRE



Scraper, triangular
Dreieckiges schabeisen
Raspador triangular

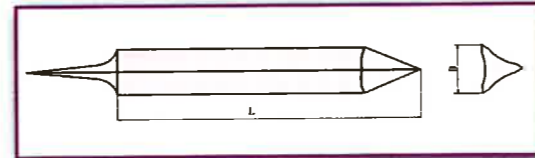

L mm	B mm	Qualité	Réf
160	22	Be-Cu Al-Br	008522 023322
300	26	Be-Cu Al-Br	008526 023326

AIGUILLE D'AUDITION



Hearing Needle
Hörfähigkeit Nadel
Aguja de la audiencia

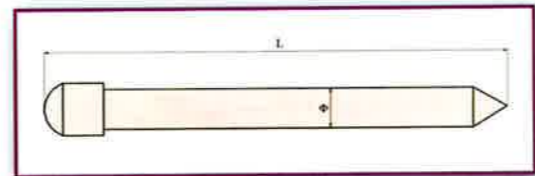

L mm	φ mm	Qualité	Réf
250	6	Be-cu	000606
300	8	Be-Cu	000608
400	7	Be-Cu	000607
500	10	Be-Cu	000610

BROCHE



Tommy Bars
Drehstift
Pasador

L mm	φ	Qualité	Réf
100	16	Be-Cu Al-Br	007201 083601
150	16	Be-Cu Al-Br	007202 083602
200	18	Be-Cu Al-Br	007203 083603

L mm	φ	Qualité	Réf
300	18	Be-Cu Al-Br	007205 083605
400	18	Be-Cu Al-Br	007206 083606
500	20	Be-Cu Al-Br	007208 083608

EXTRACTEUR 3 CROCHETS

Universal three arm puller
Universal-radabzieher drejarmig
Tirador

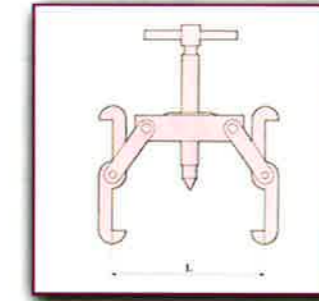

Lmin mm	Qualité	Réf
100	Be-Cu Al-Br	3282 2991
150	Be-Cu Al-Br	4052 3675
200	Be-Cu Al-Br	5991 5432
350	Be-Cu Al-Br	12352 11231

PRESSE SERRE-JOINT

Clamp
Schraubzwinde
Prensa

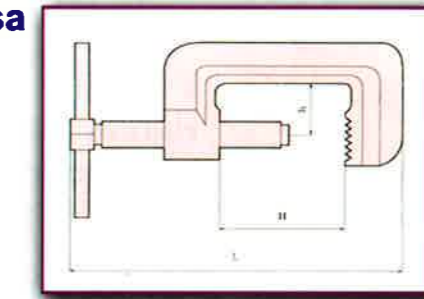

L mm	H mm	h mm	Qualité	Réf
210	60	36	Be-Cu Al-Br	006301 021101
250	80	36	Be-Cu Al-Br	006303 021103
290	100	36	Be-Cu Al-Br	006305 021105

PALAN MANUEL ANTI - ETINCELANT



Chain hoist
Flaschenzug
Alzamiento de cardara

kg	Qualité	Réf
500	Be-Cu Al-Br	000705 000745
1000	Be-Cu Al-Br	000710 000750
2000	Be-Cu Al-Br	000720 000760
3000	Be-Cu Al-Br	000730 000770



OUVRE TONNEAU A CARBURE

L mm	B mm	Qualité	Réf
180	53	Be-Cu Al-Br	002501 017401

Carbide drum opener
Karbiddrommelöffner
Abridor de Toneles de Carburo



SEAU

Ø mm	H mm	Qualité	Réf
270	248	Be-Cu	077002

Bucket
Eimer
Balde

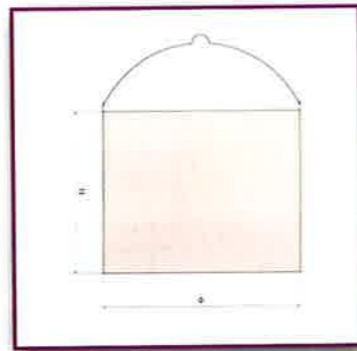

RAMASSE - POUSSIÈRES

L mm	B mm	H mm	Qualité	Réf
200	200	50	Be-Cu	012605

Dust pan
Handschaukel
Recogedor

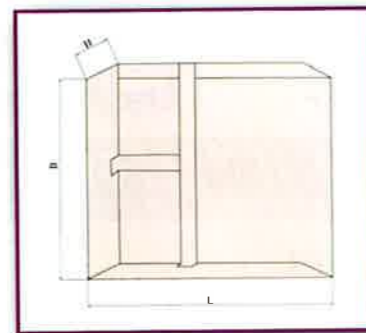

RECIPIENT A GRANULES ET LIQUIDES

L mm	H mm	Ø mm	Ø mm	Qualité	Réf
350	90	160	135	Be-Cu	077102

Sugar scoop
Schöpfschaufel
Cuchara Recogedora de Azucar

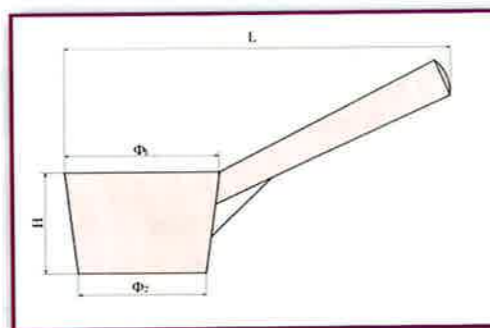

ENTONNOIR



Funnel
Trichter
Embudo

Ø	H mm	Qualité	Réf
160	130	Be-Cu	029012
160	150	Be-Cu	029015

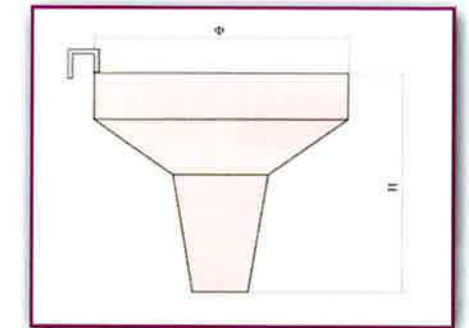

POMPE A PISTON POUR HUILE



Piston pump for oil
Kolbenpumpe für öl
Bomba a piston para aceite

Ø	H mm	Qualité	Réf
165	1100	Be-Cu	079302

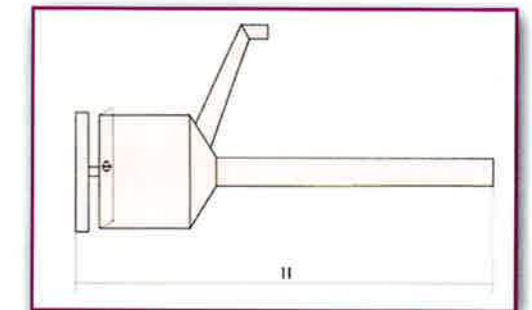

MESURE



Measure
Maßnahme
Medida

Ø	L mm	Qualité	Réf
85	350	Be-Cu	079402

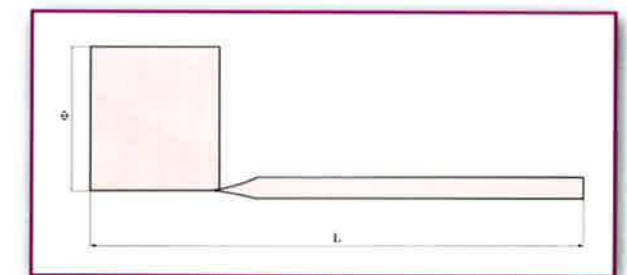

SCIE A METAUX

L mm	D mm	H mm	Qualité	Réf
500	300	110	Be-cu Al-br	003001 017901

* Livrée sans lame
* Without blade

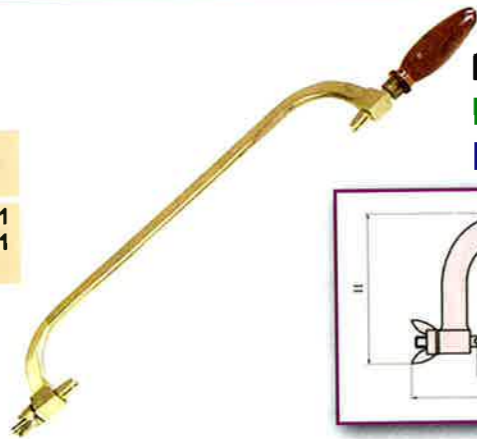

Hack saw frame
Bügelsäge DIN 6473
Marco para Sierra de Corte

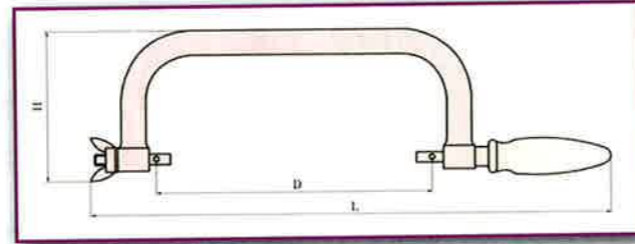

LAME DE SCIE

L mm	B mm	Qualité	Réf
300	12	Be-Cu	003101

Blade, hack saw
Sägeblatt
Hoja de Sierra de Corte



SCIE EGOINE

L mm	H mm	Qualité	Réf
370	114	Be-Cu	003202



Hand saw
Handsäge
Serrucho de Mano

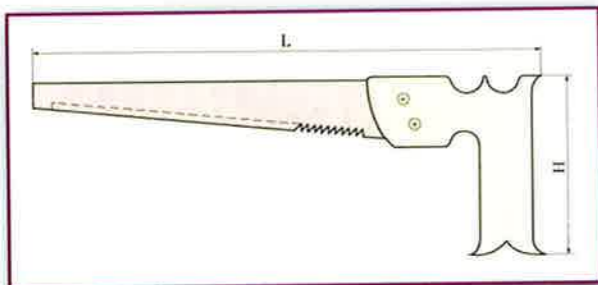

BLOC NOTES

Blank lined area for notes.